

Tag-it™ HF-I Transponder IC TMS37112

Reference Guide

July 2005



Tag-it™ HF-I Transponder IC TMS37112

Reference Guide



Literature Number: SCBU011
July 2005



Preface	5
1 Introduction	7
1.1 General.....	8
1.2 System Description	8
1.3 Product Description.....	9
1.4 Functional Description.....	9
1.5 Memory Organization	10
1.6 Command Set	11
1.7 Ordering Information and Part Numbers	11
2 Specification	13
2.1 Electrical Specification	14
2.2 Mechanical Wafer Specification	14
2.3 Mechanical Die Specification	16
2.4 Bump Specification.....	17
3 Shipping, Packing, and Further Handling	19
3.1 Lot Definition	20
3.2 Wafer Identification.....	20
3.3 Wafer Map File	21
3.4 Ink Dot Specification	22
3.5 Packing for Wafers.....	23
3.6 Packing for Sawn Wafers	24
3.7 Barcode Label	26
3.8 Storage Conditions.....	26
4 Regulatory, Safety, and Warranty Notices	27
4.1 Regulatory, Safety, and Warranty Notices.....	28
4.2 Warranty and Liability.....	28
4.3 Hazards from Electrostatic Discharge ESD.....	28
A Terms and Abbreviations	29

List of Figures

1-1	RFID System With Reader, Antenna, and Tag-it™ HF-I Transponder	8
1-2	Memory Organization of the Tag-it HF-I Transponder IC	10
2-1	Wafer on FFC.....	15
2-2	Antenna and Test Pad Location.....	17
2-3	Cross Section of Bump	18
3-1	Position of Wafer Identification Code	20
3-2	Wafer Identification Code 1	21
3-3	Wafer Identification Code 2	21
3-4	Ink Dot Drawing	23
3-5	Packing of Wafers.....	24
3-6	Packing of Sawn Wafers	25
3-7	Barcode Label	26

List of Tables

1-1	Tag-it HF-I Transponder IC Command Set	11
1-2	Part Numbers	11
2-1	Absolute Maximum Ratings	14
2-2	Recommended Operating Conditions	14
2-3	Electrical Characteristics	14
2-4	General Mechanical Wafer Specification.....	14
2-5	Mechanical Wafer Specification After Grinding, Sawing on FFC	15
2-6	Mechanical Die Specification	16
2-7	Antenna and Test Pad Location.....	16
2-8	Bump Specification.....	17
3-1	Ink Dot Specification	22
3-2	Ink Dot Placement.....	23
3-3	Storage Conditions	26

Read This First

Edition One - July 2005

This is the first edition of this reference guide. It contains a description of the Tag-it HF-I Transponder IC (TMS37112B3), the specifications, dimensions and instructions for further handling.

About This Guide

This reference guide for the Tag-it™ HF-I transponder IC is designed for use by TI partners who are engineers experienced with radio frequency identification devices (RFIDs) and the processing of wafers.

Regulatory, safety, and warranty notices that must be followed are given in Chapter 4.

Conventions

WARNING

A warning is used where care must be taken or a certain procedure must be followed, in order to prevent injury or harm to your health.

CAUTION

This indicates information on conditions that must be met or a procedure that must be followed, which if not heeded, could cause permanent damage to the equipment or software.

Note: Indicates conditions that must be met or procedures that must be followed, to ensure proper functioning of any equipment or software.

Indicates information that makes usage of the equipment or software easier.

If You Need Assistance

For more information, please contact the sales office or distributor nearest you. This contact information can be found on our web site at: <http://www.ti-rfid.com>.

Trademarks

TIRIS, TI-RFid, and Tag-it are trademarks of Texas Instruments.

All other trademarks are the property of their respective owners.

Introduction

This chapter introduces you to the Tag-it™ HF-I transponder IC.

Topic	Page
1.1 General.....	8
1.2 System Description.....	8
1.3 Product Description	9
1.4 Functional Description	9
1.5 Memory Organization	10
1.6 Command Set.....	11
1.7 Ordering Information and Part Numbers	11

1.1 General

The Tag-it™ HF-I transponder IC is part of TI's 13.56-MHz product family that is based on the ISO/IEC 15693 standard for contactless integrated circuit cards (vicinity cards) and ISO/IEC 18000-3 standard for item management. The Tag-it HF-I transponder IC builds the basis for various available inlay shapes, which are used as consumable smart labels in markets requiring quick and accurate identification of items, such as:

- Asset tagging
- Electronic ticketing
- Anti-counterfeit prevention
- Building access badges
- Distribution logistics and supply-chain management
- Building access badges
- Express parcel delivery
- Airline boarding passes and baggage handling

User data is written to and read from memory blocks using a nonvolatile EEPROM silicon technology. Each block is separately programmable by the user and can be locked to protect data from modification. Once the data has been locked, it cannot be changed.

For example, information about delivery checkpoints and timing, place of origin/destination, pallet assignments, inventory numbers and even transportation routes can be coded into the transponder.

Multiple transponders, which appear in the reader RF field, can be identified, read from, and written to by using the unique identifier (UID) that is programmed and locked at the factory.

1.2 System Description

For operation, a reader with antenna is required to send a command to the transponder and to receive its response (see [Figure 1-1](#)). The command of the reader can be either in addressed or nonaddressed mode. The transponder does not transmit data until the reader sends a request (reader talks first principle).

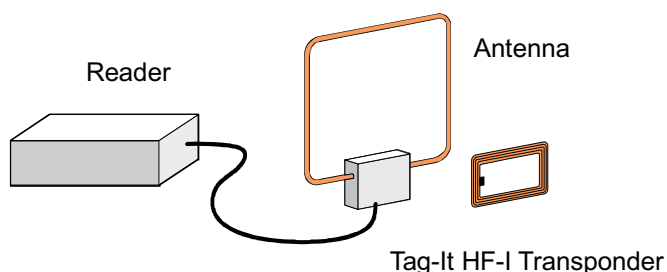

Figure 1-1. RFID System With Reader, Antenna, and Tag-it™ HF-I Transponder

1.3 Product Description

The Tag-it HF-I transponder IC is based on and fully compliant with the ISO/IEC 15693 standard. To build a complete transponder, the Tag-it HF-I transponder IC must build a resonance circuit with the external antenna it is assembled on, e.g., an etched aluminium antenna.

Note: Since the Tag-it HF-I transponder IC has no integrated resonance capacitor (only internal parasitic capacitance), it is recommended to build an additional capacitor as part of the antenna or to use an external component.

1.4 Functional Description

The Tag-it HF-I transponder IC is a low-power, full-duplex transponder IC for use with passive contactless identification transponder systems. The transponder IC is designed to operate with a 13.56-MHz carrier frequency. The ISO standard defines communication parameters in several modes in order to meet different international radio regulations and different application requirements. Therefore, communication between the reader and the transponder (Down-Link communication) takes place using ASK modulation index between 10% and 30% or 100% and datacoding (pulse position modulation) '1 out of 4' or '1 out of 256'.

According to ISO 15693 Up-link, communication (transponder to reader) can be accomplished with one subcarrier (ASK modulation) or with two subcarriers (FSK modulation). Both modes (ASK and FSK) can operate with either high or low data rate. The transponder will answer in the mode it was interrogated from the reader and supports all communication parameter combinations. Up- and Down-Link are frame synchronized and CRC checksum secured.

Each Tag-it HF-I transponder has a unique identifier (UID) address stored in two blocks that are factory-programmed and 64 bits long ($=2^{64}$ different addresses). This can be used for addressing each transponder uniquely and individually for a one-to-one exchange between the reader and the transponder. A mechanism to resolve collisions of a multiplicity of transponders (anti-collision) is also implemented. This special feature allows multiple transponders to be read simultaneously and offers the capability to inventory in a very short time a large number of transponders by their unique address, provided they are within the reader operating range.

Also, the application family identifier (AFI) and the data storage format identifier (DSFID), which are optional in the ISO15693, are supported by the Tag-it HF-I transponder.

For more details about the communication between reader and transponder, see ISO 15693.

Besides the ISO 15693-defined functionality, the Tag-it HF-I transponder IC supports a range of additional specific functions, providing additional application flexibility for the customer:

- A second lock bit per block is designated for Factory Lock. That means that every block of the user memory can be factory locked during production.
- The ISO Inventory Mode command has been defined in the standard as a stand-alone command to receive DSFID and UID. For more system flexibility, TI's Tag-it HF-I transponder also allows the combination of the Inventory command with other commands (see [Table 1-1](#)).
- Besides the ISO 15693-3 defined commands, TI has implemented additional manufacturer-specific commands that are listed in [Table 1-1](#).

1.5 Memory Organization

User data is read and stored in a 2-kbit nonvolatile user memory that is organized in 64 blocks. Each block with 32 bits is user programmable and can be locked individually to protect data from modification. Once set, the lock bit cannot be reset. The user memory is field programmable per block. Two levels of block locking are supported – individual block locking by the user (U) or individual block locking of factory programmed data (F) during manufacturing. Bit 2 of the Block Security Status byte, defined in ISO 15693-3, is used to store the Factory Lock status of the block. Block locking irreversibly protects the locked data from any further reprogramming. A factory-programmed block contains the IC reference and the physical memory info (block size and number of blocks)

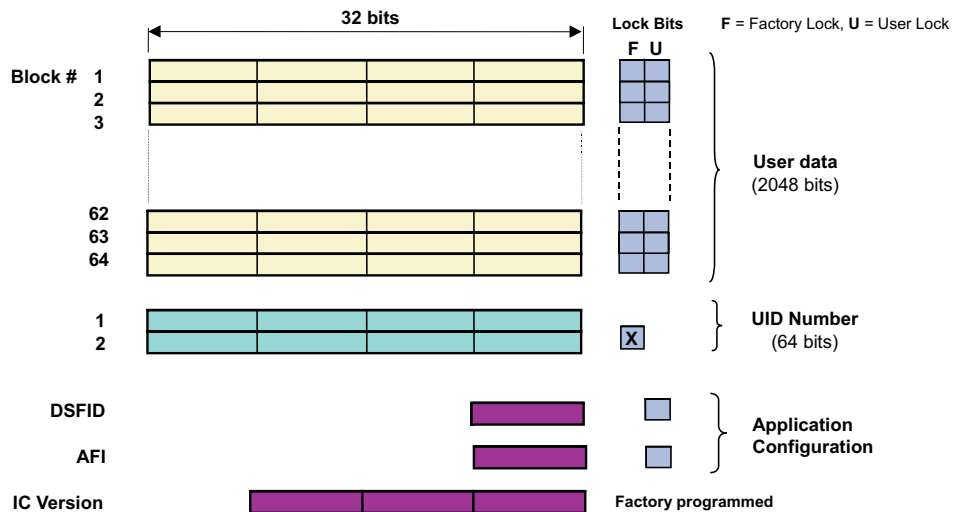

Figure 1-2. Memory Organization of the Tag-it HF-I Transponder IC

1.6 Command Set

Table 1-1. Tag-it HF-I Transponder IC Command Set

REQUEST	REQUEST MODE ⁽¹⁾						
	REQUEST CODE	INVENTORY	ADDRESSED	NON-ADDRESSED	SELECT	AFI	OPT. FLAG
ISO 15693 Mandatory Commands							
Inventory	0x01	ü	–	–	–	ü	–
Stay Quiet	0x02	–	ü	–	–	–	–
ISO 15693 Optional Commands							
Read_Single_Block	0x20	ü	ü	ü	ü	ü	0/1
Write_Single_Block	0x21	–	ü	ü	ü	–	1
Lock_Block	0x22	–	ü	ü	ü	–	1
Read_Multi_Blocks	0x23	ü	ü	ü	ü	ü	0/1
Write_Multi_Blocks	0x24	–	–	–	–	–	–
Select Tag	0x25	–	ü	–	–	–	–
Reset to Ready	0x26	–	ü	ü	ü	–	–
Write_AFI	0x27	–	ü	ü	ü	–	1
Lock_AFI	0x28	–	ü	ü	ü	–	1
Write_DSFD	0x29	–	ü	ü	ü	–	1
Lock_DSFD	0x2A	–	ü	ü	ü	–	1
Get_System_info	0x2B	ü	ü	ü	ü	ü	–
Get_M_Blkc_Sec_St	0x2C	ü	ü	ü	ü	ü	–
TI Custom Commands							
Write_2_Block	0xA2	–	ü	ü	ü	–	1
Lock_2_Block	0xA3	–	ü	ü	ü	–	1

- (1) ü = Implemented,
– = Not applicable,
0/1 = Option Flag needed

Note: The option flag (Bit 7) of the ISO 15693-defined Request flags must be set to 1 for all Write and Lock commands to respond properly.

For reliable programming, we recommend a programming time ≥ 10 ms before the reader sends the end of frame (EOF) to request the response from the transponder.

1.7 Ordering Information and Part Numbers

The Tag-it HF-I transponder IC is available with two finishing options (see Table 1-2).

Table 1-2. Part Numbers

PART NUMBER	BUMPING	INKING	GRINDING	SAWING
RF-HDT-WJMC-M0	Yes	No	No	No
RF-HDT-SJMC-G0	Yes	Yes	Yes	Yes

Specification

This chapter provides the electrical and mechanical specifications of the Tag-it™ HF-I transponder IC.

Topic	Page
2.1 Electrical Specification	14
2.2 Mechanical Wafer Specification	14
2.3 Mechanical Die Specification	16
2.4 Bump Specification	17

2.1 Electrical Specification

Table 2-1. Absolute Maximum Ratings⁽¹⁾

PARAMETER		MIN	MAX	UNIT
I _{ant_dc}	Antenna input current		10	mA
V _{ant_dc}	Antenna input voltage		10	V
T _S	Storage temperature	-40	125	°C
T _J	Junction (Chip) temperature		150	°C
ESD immunity	Human-Body Model (HBM)	ANT1, ANT2	3	kV
		TDAT, GND	2	

⁽¹⁾ Stress beyond the limits of those listed under Absolute Maximum Ratings may cause permanent damage to the device. Functional operation of the device under these or any other conditions beyond those indicated under Recommended Operating Conditions is not implied. Exposure to absolute-maximum-rated conditions for extended time may affect device reliability.

Table 2-2. Recommended Operating Conditions

PARAMETER		MIN	NOM	MAX	UNIT
T _A	Operating temperature	-40		85	°C
f _{TX}	Carrier frequency		13.56		MHz
V _{ANT}	Antenna input voltage	At f _{TX} unmodulated		V _{lim}	V
Z	Impedance of LC circuit	6.5		15.5	kΩ

Table 2-3. Electrical Characteristics

PARAMETER		TEST CONDITIONS	MIN	NOM	MAX	UNIT
C _{IN}	Input capacitance	At 2V _{RMS}		2.4		pF
I _{CC}	Operating supply current	V _{ANT} = min			50	μA
M _{PICC}	Uplink modulation index	V _{ANT} < 7 V	0.1		0.3	
V _{lim}	Limiter clamping voltage				10	V
t _{DRET}	Data retention	55°C	10			Years
W&E	Write and erase endurance	T _A = 25°C	100,000			Cycles

Note: For highest possible read-out coverage, it is recommended to operate readers at a modulation depth of 20% or higher.

2.2 Mechanical Wafer Specification

Table 2-4. General Mechanical Wafer Specification

PARAMETER	VALUE
Wafer diameter	200 mm ± 0.3 mm (8 in)
Thickness	711 μm
Scribe line width	110 μm
Electrical connection of substrate	VSS potential
Complete dies per wafer	16422

Table 2-5. Mechanical Wafer Specification After Grinding, Sawing on FFC

PARAMETER		VALUE
Thickness		265 ± 13 μm
Backside Material		Si
Roughness	Ra	500 Angstrom
	Rtm	2500 Angstrom

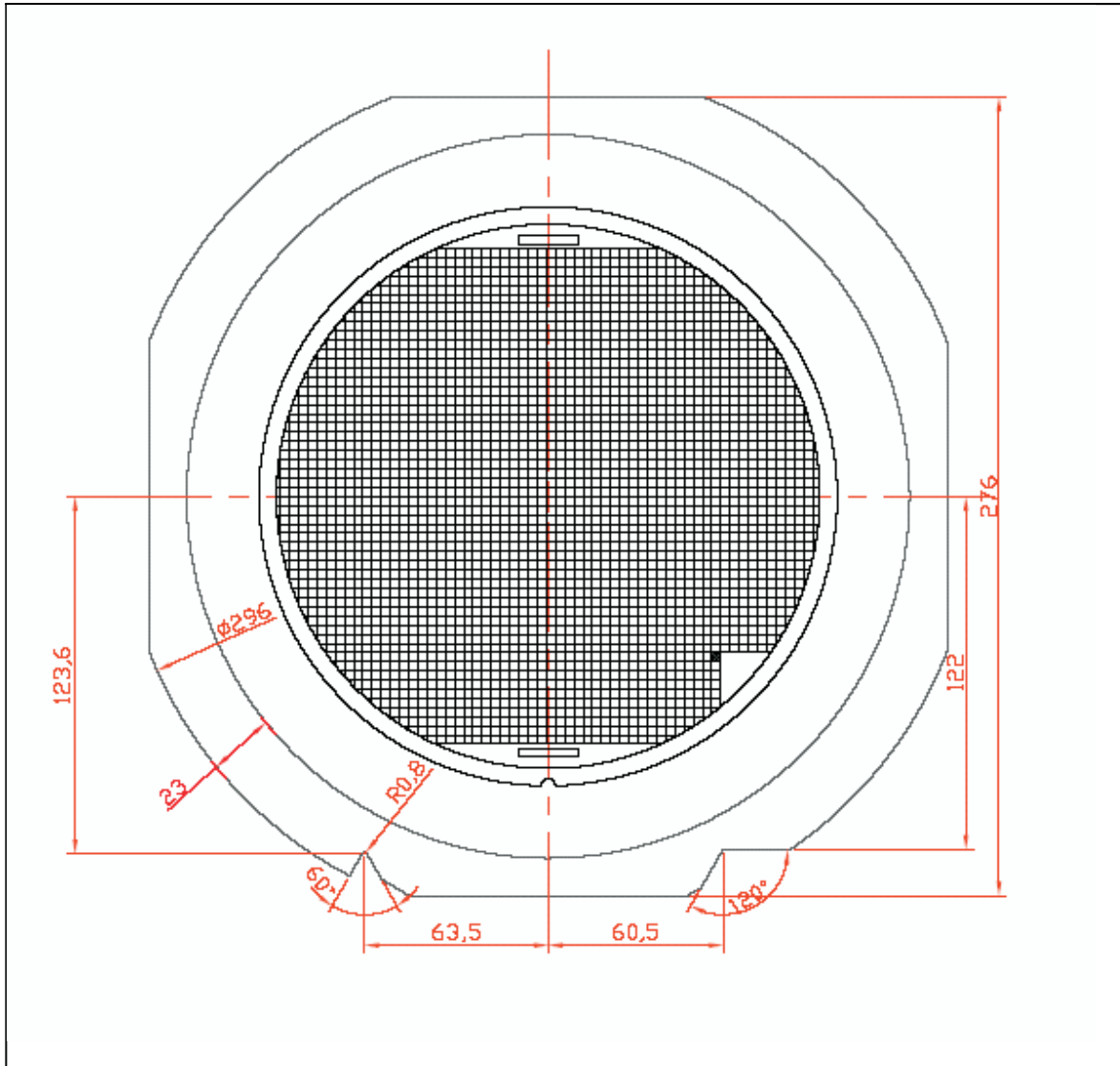

Figure 2-1. Wafer on FFC

2.3 Mechanical Die Specification

Table 2-6. Mechanical Die Specification

PARAMETER	VALUE
Antenna pad size	Pad 1: 100 × 200 μm, Pad 5, 6, 8: 200 × 200 μm
Test pad size	Pad 2, 3, 4: 50 × 70 μm
GND test pad	Pad 7: 90 × 90 μm
Bond pad metallization material	ALCu 0.5%
Bond pad metallization thickness	0.95 μm
Bond and test pad location	Table 2-7
Die dimension (including scribe line)	1406 μm × 1226 μm ±15 μm
Die dimension (excluding scribe line)	1296 μm × 1116 μm ±15 μm
Top-side passivation material	SiNi
Passivation thickness	1.1 μm

Table 2-7. Antenna and Test Pad Location

PAD NO.	NAME	LLCx[μm]	LLCy[μm]	URCx[μm]	URCy[μm]
1	ANT1	32	984	232	1084
5	ANT2	1064	884	1264	1084
6	ANT2	1064	32	1264	232
8	ANT1	32	32	232	232
Test Pad					
2	TDI	518	1014	568	1084
3	VCCA	623	1014	673	1084
4	TDO	728	1014	778	1084
7	GND	645	90	735	180

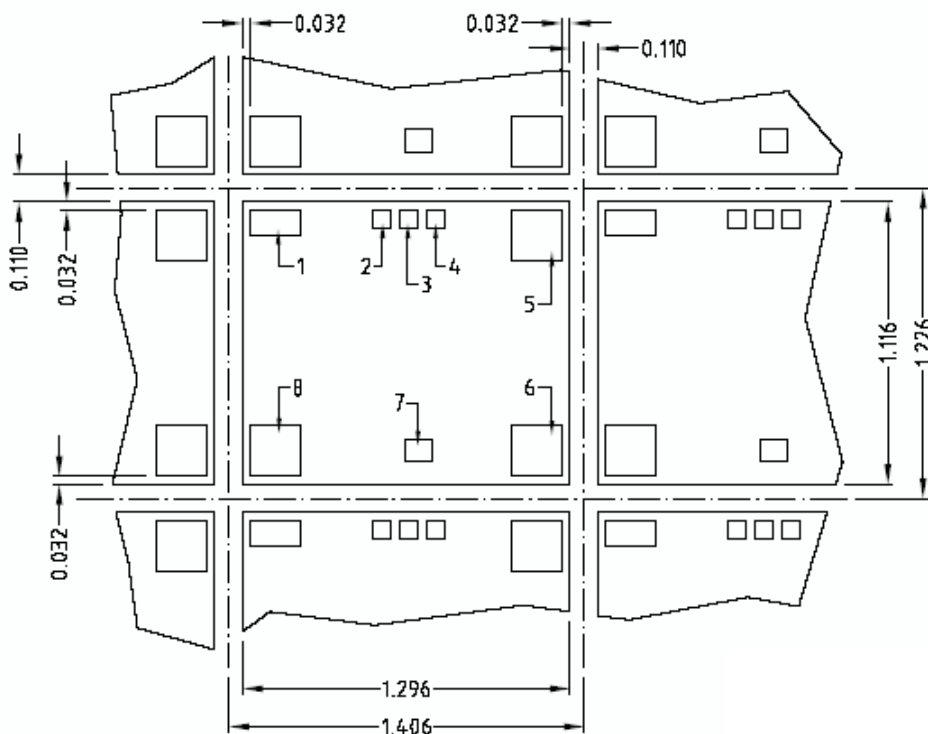

Figure 2-2. Antenna and Test Pad Location

2.4 Bump Specification

Table 2-8. Bump Specification

PARAMETER	VALUE
Bump material	Ni covered with AU, chemical process
Bump height	25 $\mu\text{m} \pm 10\%$
Bump hardness	>HV 450
Surface roughness	<1 μm
Shear strength	>150 cN
Contact resistance between bump and AL-substrate	<25 m Ω

Bump Specification

Note: Test pads are not bumped. Contact between the test pads and the antenna is not allowed as it can have an impact on the electrical performance of the transponder.

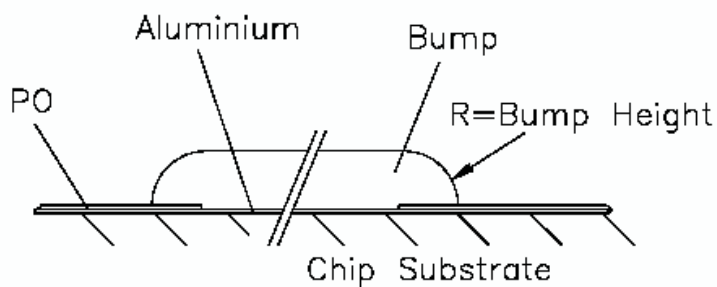

Figure 2-3. Cross Section of Bump

Shipping, Packing, and Further Handling

Topic	Page
3.1 Lot Definition	20
3.2 Wafer Identification	20
3.3 Wafer Map File	21
3.4 Ink Dot Specification	22
3.5 Packing for Wafers	23
3.6 Packing for Sawn Wafers	24
3.7 Barcode Label	26
3.8 Storage Conditions	26

3.1 Lot Definition

A lot is a definite quantity of wafers from the same diffusion batch produced under presumed uniform conditions. Occasionally a lot equals 25 wafers.

3.2 Wafer Identification

Each wafer is marked with laser marking to identify the wafer. The wafer map file is linked to the wafer id. There are 2 marks on the wafer.

Figure 3-1 shows the position of the wafer identification codes. The reference die is the black marked die in the corner at the right lower position of the wafer.

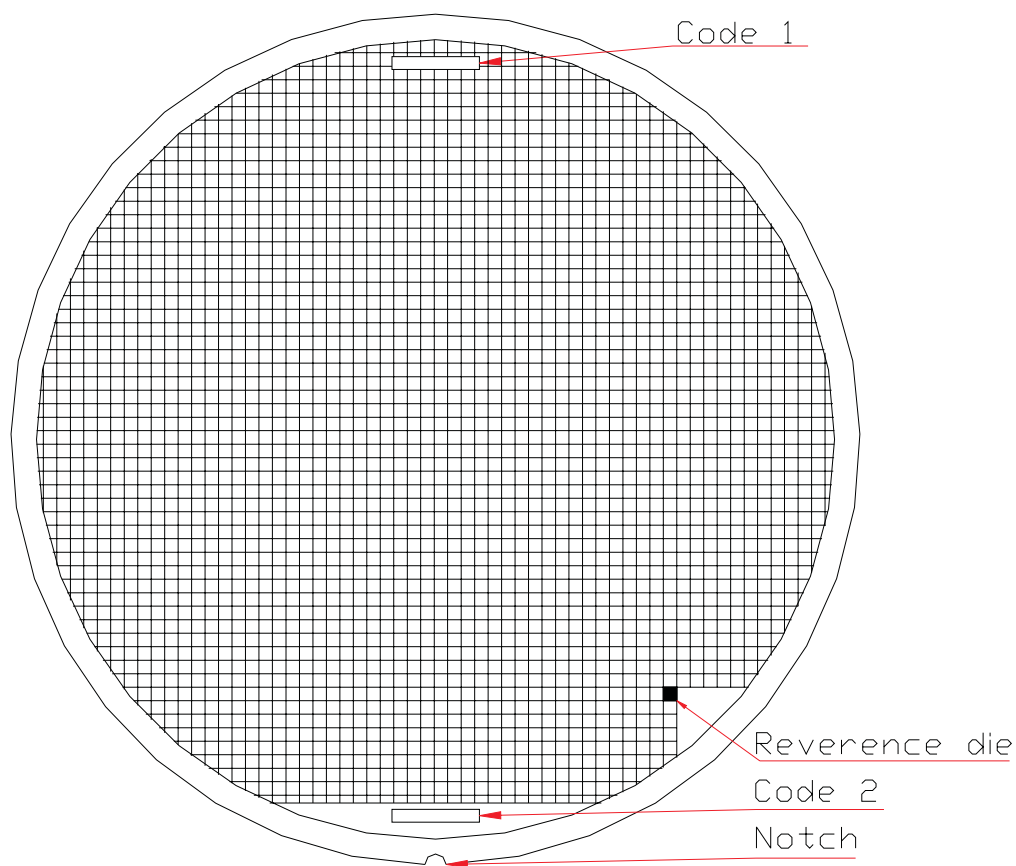

Figure 3-1. Position of Wafer Identification Code

Code 1: Wafer Lot Number Naming Rule

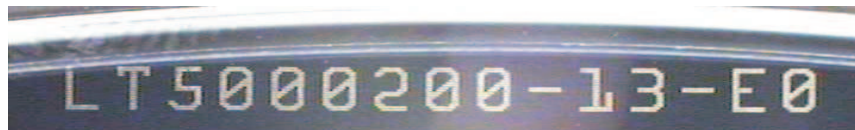
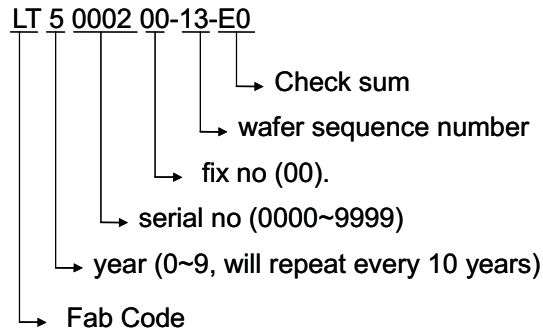

Figure 3-2. Wafer Identification Code 1

Code 2: Wafer Lot Number Naming Rule

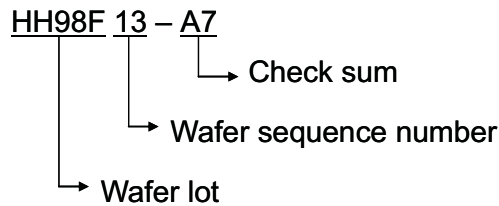
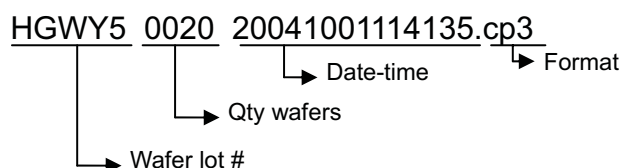

Figure 3-3. Wafer Identification Code 2

3.3 Wafer Map File

All lots are supplied with wafer mapping file. This mapping file is stored on a CD and enclosed in the pack box.

The mapping file is stored for three years, in case a problem may occur. TI handles our worldwide wafer map standard. The wafer file name is explained as:



Ink Dot Specification

The standard TI worldwide wafer map file is .cp3. This is an ASCII format. The most important facts are sorted out in a list (see the following example). The lot definition also can be found in this list. Also, the tested dies and pass dies are shown.

```

CUSTOMER ID      : TIG
FAB ID           : FAB8E
PRODUCT ID       : W37112B3
CUST PRODUCT ID  : W37112B3
FAB PRODUCT ID   : H3337F-NZWN
LOT ID           : HGWY5.00
CUST LOT ID      :
FAB LOT ID       : N47HGWY5.00
WAFER ID         : 20
FLOW ID          : CP3
PRODUCT VERSION  : 6
START TIME       : 2004/10/01 11:41:35
STOP TIME        : 2004/10/01 11:53:41
SUBCON           : UMC01
TESTER NAME      : J750#76
TEST PROGRAM     : TMS37112BP3C1
LOAD BOARD ID    :
PROBE CARD ID    : JATCYH03
SITE NUM         :
DUT ID           :
DUT DIFF NUM     :
OPERATOR ID      : 8341
GROSS DIE        : 16268
TESTED DIE       : 16268
PASS DIE         : 15723
YIELD            : 96.65%
PROBING NOTCH    : DOWN
MAP NOTCH        : DOWN
MAP ROW          : 154
MAP COLUMN       : 137
MAP BIN LENGTH   : 2
SHIP             : YES

```

3.4 Ink Dot Specification

All Tag-it HF-I transponder ICs are electrically tested, and dies that fail the probe test will be inked. Bump failures are not marked with an ink dot.

Table 3-1. Ink Dot Specification

PARAMETER	VALUE
Diameter	Minimum 400 μm
	Maximum 700 μm
Height	Maximum 25 μm
Color	Black
Position	Central, not on bond pads

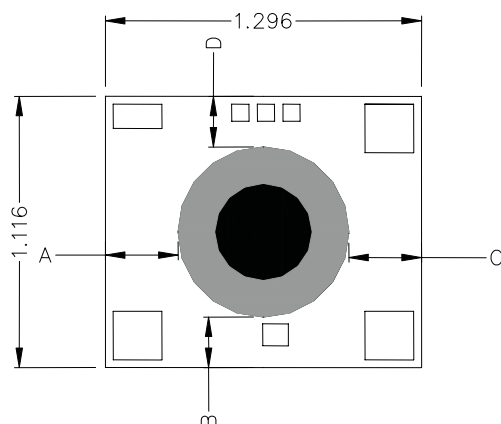

Figure 3-4. Ink Dot Drawing

Table 3-2. Ink Dot Placement

NO.	MAX	MIN	REMARK
A	550	200	
B	400	200	
C	550	200	
D	400	150	
Ink	700	400	Size limit

3.5 Packing for Wafers

The wafers are packed for transportation to protect them against shock, static discharge, and contamination in a wafer-shipper box up to 25 wafers. This box is packed in an antistatic moisture bag with silica gel and in a double-layered carton box.

Note: When the silica gel has changed color to blue, it is an indication that moisture has entered the bag.

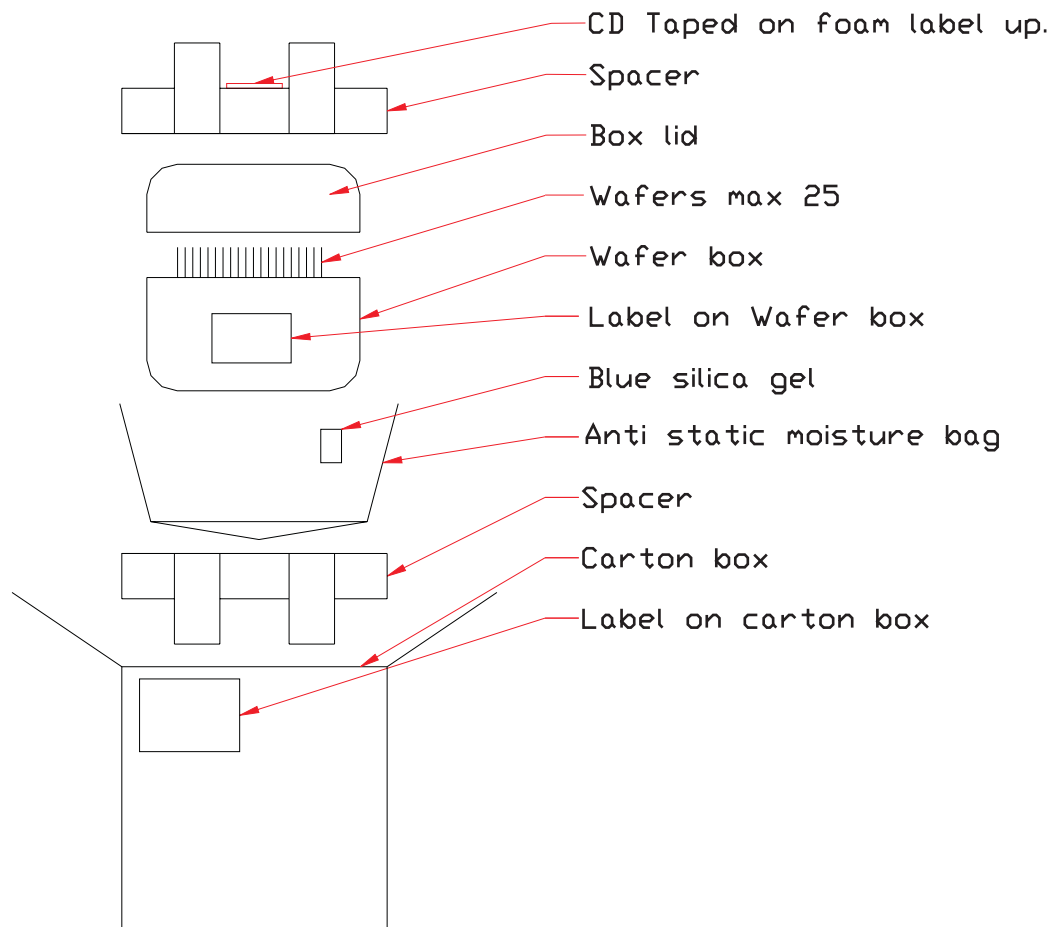

Figure 3-5. Packing of Wafers

3.6 Packing for Sawn Wafers

Sawn wafers are mounted on foil and delivered on standard 8-in disco wafer frame (see [Figure 2-1](#)). A special plastic container is used to store up to 25 wafers in frames. This plastic container is packed in an antistatic moisture bag with silica gel and in a double-layered carton box.

Note: When the silica gel has changed color to blue, it is an indication that moisture has entered the bag.

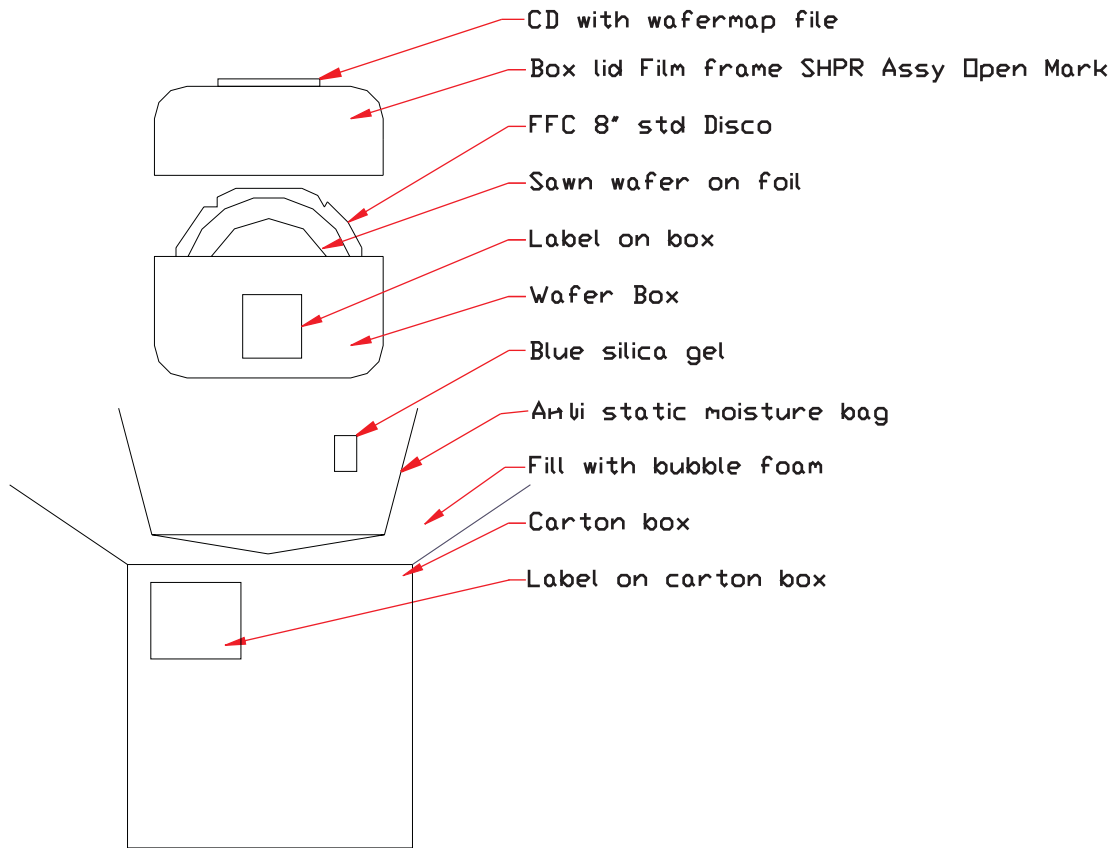

Figure 3-6. Packing of Sawn Wafers

3.7 Barcode Label

Figure 3-7 shows the barcode label that is placed on the packaging box, the wafer container, and the CD with the map file.

Note: The data provided below is an example and should only be viewed as guide values.

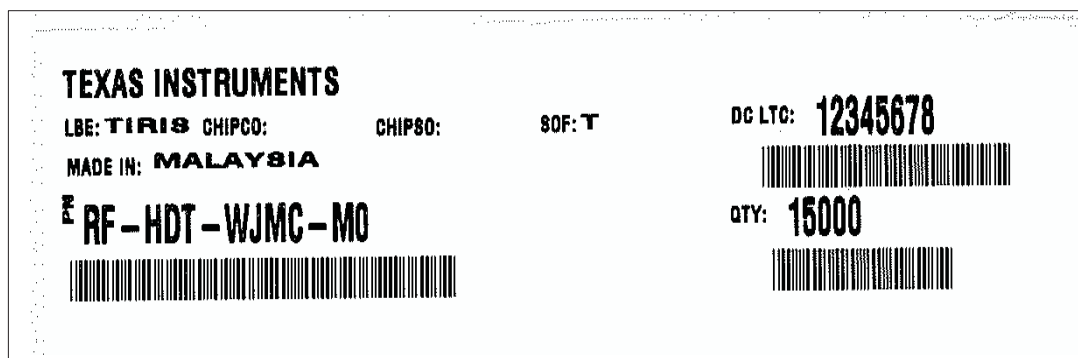

Figure 3-7. Barcode Label

PN	Part Number
QTY	Quantity of functional inlays per reel total quantity (including nonfunctional units) may exceed this number
DC LTC	Datecode; Lot Number

3.8 Storage Conditions

The wafers should be kept in the original packing during storage.

Table 3-3. Storage Conditions

PARAMETER	VALUE
Temperature	20°C ± 5°C
Atmosphere	Dried N ₂ or dried air with 40%–60% r.h.
Duration	Maximum 6 months

Regulatory, Safety, and Warranty Notices

This chapter describes important safety precautions and safety regulations.

Topic	Page
4.1 Regulatory, Safety, and Warranty Notices	28
4.2 Warranty and Liability.....	28
4.3 Hazards from Electrostatic Discharge ESD	28

4.1 Regulatory, Safety, and Warranty Notices

An RFID system comprises an RF transmission device and is, therefore, subject to national and international regulations.

A system reading from or writing to these transponders may be operated only under an experimental license or final approval issued by the relevant approval authority. Before any such device or system can be marketed, an equipment authorization must be obtained from the relevant approval authority.

The Tag-it HF-I transponder IC has been manufactured using state-of-the-art technology and in accordance with the recognized safety rules.

Observe Precautions In Operating Instructions

- Condition for the safe processing, handling, and fault-free operation of the Tag-it HF-I transponder IC is the knowledge of the basic safety regulations.
- All persons who operate the Tag-it HF-I transponder IC must observe the guidelines and, particularly, the safety precautions outlined in this document.
- In addition, basic rules and regulations for accident prevention applicable to the operating site must also be considered.

4.2 Warranty and Liability

The "General Conditions of Sale and Delivery" of Texas Instruments Incorporated or a TI subsidiary apply. Warranty and liability claims for defective products and injuries to persons and property damages are void if they are the result of one or more of the following causes:

- Improper use of the transponder IC
- Unauthorized assembly, operation, and maintenance of the transponder IC
- Operation of the transponder IC with defective and/or nonfunctioning safety and protective equipment
- Failure to observe the instructions given in this document during transport, storage, assembly, operation, maintenance, and setting up of the transponder IC
- Unauthorized changes to the transponder IC
- Insufficient monitoring of the transponder IC operation or environmental conditions
- Repairs
- Catastrophes caused by foreign bodies and natural disasters

CAUTION

Tag-it HF-I transponder ICs are 100% thoroughly tested. It is the responsibility of TI's customer to evaluate their assembly process for compatibility with the Tag-it HF-I transponder IC properties and to ensure through appropriate process controls that determined machine and material parameter are met on an ongoing basis. TI does not accept warranty claims for material that has already undergone packaging or conversion process.

4.3 Hazards from Electrostatic Discharge ESD

WARNING

ELECTRONIC DEVICES CAN ALSO BE DESTROYED BY ELECTROSTATIC ENERGY.

Terms and Abbreviations

A list of the abbreviations and terms used in the various TI manuals can be found in a separate manual:

TI-RFid™ Product Manual Terms & Abbreviations

Literature number SCBU014 (11-03-21-002)

IMPORTANT NOTICE

Texas Instruments Incorporated and its subsidiaries (TI) reserve the right to make corrections, modifications, enhancements, improvements, and other changes to its products and services at any time and to discontinue any product or service without notice. Customers should obtain the latest relevant information before placing orders and should verify that such information is current and complete. All products are sold subject to TI's terms and conditions of sale supplied at the time of order acknowledgment.

TI warrants performance of its hardware products to the specifications applicable at the time of sale in accordance with TI's standard warranty. Testing and other quality control techniques are used to the extent TI deems necessary to support this warranty. Except where mandated by government requirements, testing of all parameters of each product is not necessarily performed.

TI assumes no liability for applications assistance or customer product design. Customers are responsible for their products and applications using TI components. To minimize the risks associated with customer products and applications, customers should provide adequate design and operating safeguards.

TI does not warrant or represent that any license, either express or implied, is granted under any TI patent right, copyright, mask work right, or other TI intellectual property right relating to any combination, machine, or process in which TI products or services are used. Information published by TI regarding third-party products or services does not constitute a license from TI to use such products or services or a warranty or endorsement thereof. Use of such information may require a license from a third party under the patents or other intellectual property of the third party, or a license from TI under the patents or other intellectual property of TI.

Reproduction of information in TI data books or data sheets is permissible only if reproduction is without alteration and is accompanied by all associated warranties, conditions, limitations, and notices. Reproduction of this information with alteration is an unfair and deceptive business practice. TI is not responsible or liable for such altered documentation.

Resale of TI products or services with statements different from or beyond the parameters stated by TI for that product or service voids all express and any implied warranties for the associated TI product or service and is an unfair and deceptive business practice. TI is not responsible or liable for any such statements.

Following are URLs where you can obtain information on other Texas Instruments products and application solutions:

Products		Applications	
Amplifiers	amplifier.ti.com	Audio	www.ti.com/audio
Data Converters	dataconverter.ti.com	Automotive	www.ti.com/automotive
DSP	dsp.ti.com	Broadband	www.ti.com/broadband
Interface	interface.ti.com	Digital Control	www.ti.com/digitalcontrol
Logic	logic.ti.com	Military	www.ti.com/military
Power Mgmt	power.ti.com	Optical Networking	www.ti.com/opticalnetwork
Microcontrollers	microcontroller.ti.com	Security	www.ti.com/security
Low Power Wireless	www.ti.com/lpw	Telephony	www.ti.com/telephony
		Video & Imaging	www.ti.com/video
		Wireless	www.ti.com/wireless

Mailing Address: Texas Instruments
Post Office Box 655303 Dallas, Texas 75265