

Doc No	KYT20XXSeries SPECIFICATION	REV	PAGE	DATE
		F	2 OF 27	2006. 10.30.

MODEL NAME INFORMATION

K Y X - 2 0 X X

INTERFACE	FUNCTION	TYPE	CAPACITY	THICKNESS
T: RS-232C L: TTL	2: DISPENSER	0: DUAL STACKER	5: 600 PCS(300 x 2) 6: 1000 PCS(500 x 2)	1: 0.2T 2: 0.38T 3: 0.5T 4: 0.76T 5: 0.84T 6: 1.0T

Doc No	KYT20XXSeries SPECIFICATION	REV	PAGE	DATE
		F	3 OF 27	2006. 10.30.

C o n t e n t s

1. Preview
2. Special Features
3. Specification
4. Block Diagram
5. I/O port definition
6. Interface
7. Protocol
8. Technical Drawing.

* **ATTACHEMENT**

. DISPENSER START-UP SETTING

. TROUBLE SHOOTINGN

Doc No	KYT20XXSeries SPECIFICATION	REV	PAGE	DATE
		F	4 OF 27	2006. 10.30.

1. Preview

Intelligent card dispenser KYT-20XX series is a product incorporated with new conception , which has 2 stackers in one body to make its capacity 2 times more than conventional dispenser's. 2 (Two) different types (different thickness) of card can be loaded onto each stacker, which brings cost - down and final product down-sizing.

All the processes and operations of KYT-20XX are monitored by its intelligent Microprocessor, which makes itself self-recover from faulty running.

With Error Card Bin inside its body , KYT-20XX has a function to takes an error card back to the bin. This function is called “ Capture “.

KYT-20XX series are applied and integrated to following products and systems ;

- Prepaid card vending machine
- ID card issuing machine
- Parking card vending machine
- Payphone card vending machine
- Automatic card issuing machine
- Ticketing vending machine
- And more

Doc No	KYT20XXSeries SPECIFICATION	REV	PAGE	DATE
		F	5 OF 27	2006. 10.30.

2. Features

1) Card Loading Capacity

- 0.22mm card loading capacity : 1,900 cards/stacker (total 3,800 cards of 2 stackers)
- 0.76mm card loading capacity : 500 cards/stacker (total 1,000 cards of 2 stackers)

2) Two Stackers

- Two stackers in one body makes it load 2 different types of card onto each stacker.

3) One Card Transportation Rail and Exit Slot even if it has 2 stackers .

4) Easy adjustment of dispensable card gap (thickness) by 3 screws .

- Gap adjustable : 0.22 to 1.00 mm

5) Card Capture Function

- An error card is captured to Error Card Bin.

6) Interface : RS-232 C Interface

7) It is easy to control card stop , card issuing and card capture by microprocessor.

8) Card Empty and Card Low Loading Warning signals featured.

9) Communication Baud Rates can be increased from 9,600 up to 19,200 bps.

10) The size of the product is small in consideration of its loading capacity.

11) It always monitors error and makes it recover for itself from the faulty operation.

12) Card dispensing starts from Stacker # 1 (left-hand side) and then Stacker # 2 does if cards are fully dispensed out.

Doc No	KYT20XXSeries SPECIFICATION	REV	PAGE	DATE
		F	6 OF 27	2006. 10.30.

3. Specification

MODEL	KYT2050	KYT2060
Card Loading Capacity (Card thickness : 0.76mm)	600 cards	1000 cards
Height (mm)	370	513
Weight (Kg)	5.5	6
Dispensing speed (sec)	1.5	1.6
Card applicable	Phone Card, Credit, Debit, Pre-paid, I.C, R/F, Parking Card	
Width (mm)	52 ~ 55	
Depth (mm)	80 ~ 86	
Card thickness (mm)	0.22 ~ 1.0	
Interface	RS-232C	
Supply voltage & Current consumption	Without Load : DC 24V – 0.1A. With Load : DC 24V – 2.0A.	
Operating temperature	-5℃ ~ 45℃	
Operating humidity	0 % ~ 96 % RH (without condensation)	
Operation locus	In the cabinet	

4. Block Diagram

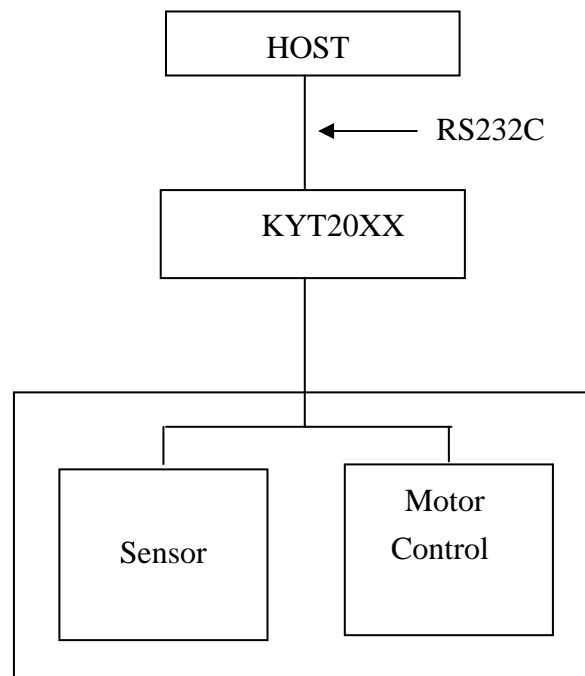

Doc No	KYT20XXSeries SPECIFICATION	REV	PAGE	DATE
		F	7 OF 27	2006. 10.30.

5. I/O Port Definition

5.1. DC Power Connector (J3)

5.1.1. Header : 5566-04A1 (MOLEX)

5.1.2. Power Connector Pin Table

Main B/D side (Male)

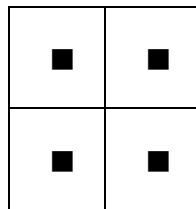

Front View (Female)

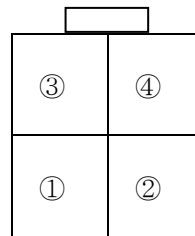

Pin NO	Signal Name	Direction
1	GND(+24V)	Input
2		
3	+24V	
4		

Power Cable

1. BLACK : GND(+24V)
3. YELLOW : +24V

Doc No	KYT20XXSeries SPECIFICATION	REV	PAGE	DATE
		F	8 OF 27	2006. 10.30.

5.2 Connection

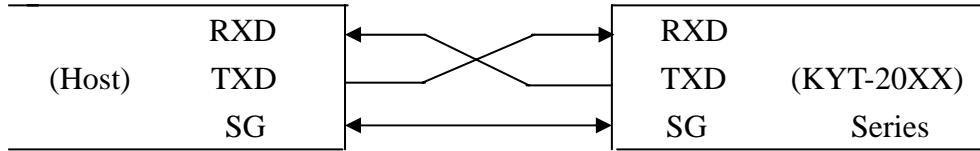

* RS232C Pin Number(J2)

Pin No	INDEX	Remark
2	RXD	Receive
3	TXD	Transmit
5	SG	Signal Ground

* RS-232C 9P(Male)

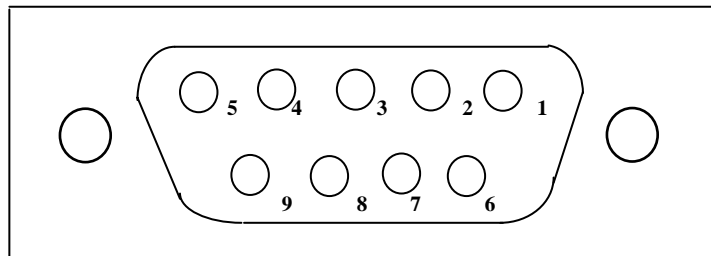

RDED-9PE-LNA(HIROSE)

Doc No	KYT20XXSeries SPECIFICATION	REV	PAGE	DATE
		F	9 OF 27	2006. 10.30.

6. Interface

< Command >

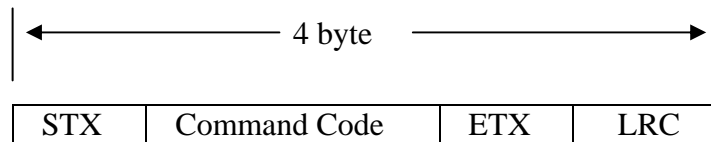

LRC : Longitudinal Redundancy Check– Calculated by EX-ORing all Characters from STX to ETX inclusive

< Response >

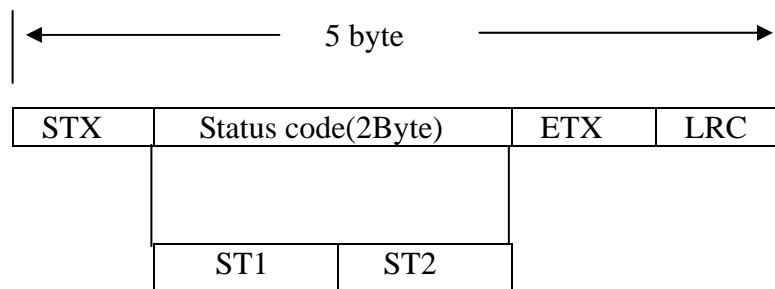

Doc No	KYT20XXSeries SPECIFICATION	REV	PAGE	DATE
		F	10 OF 27	2006. 10.30.

6.1. Status Check bit

< ST 1 Format >

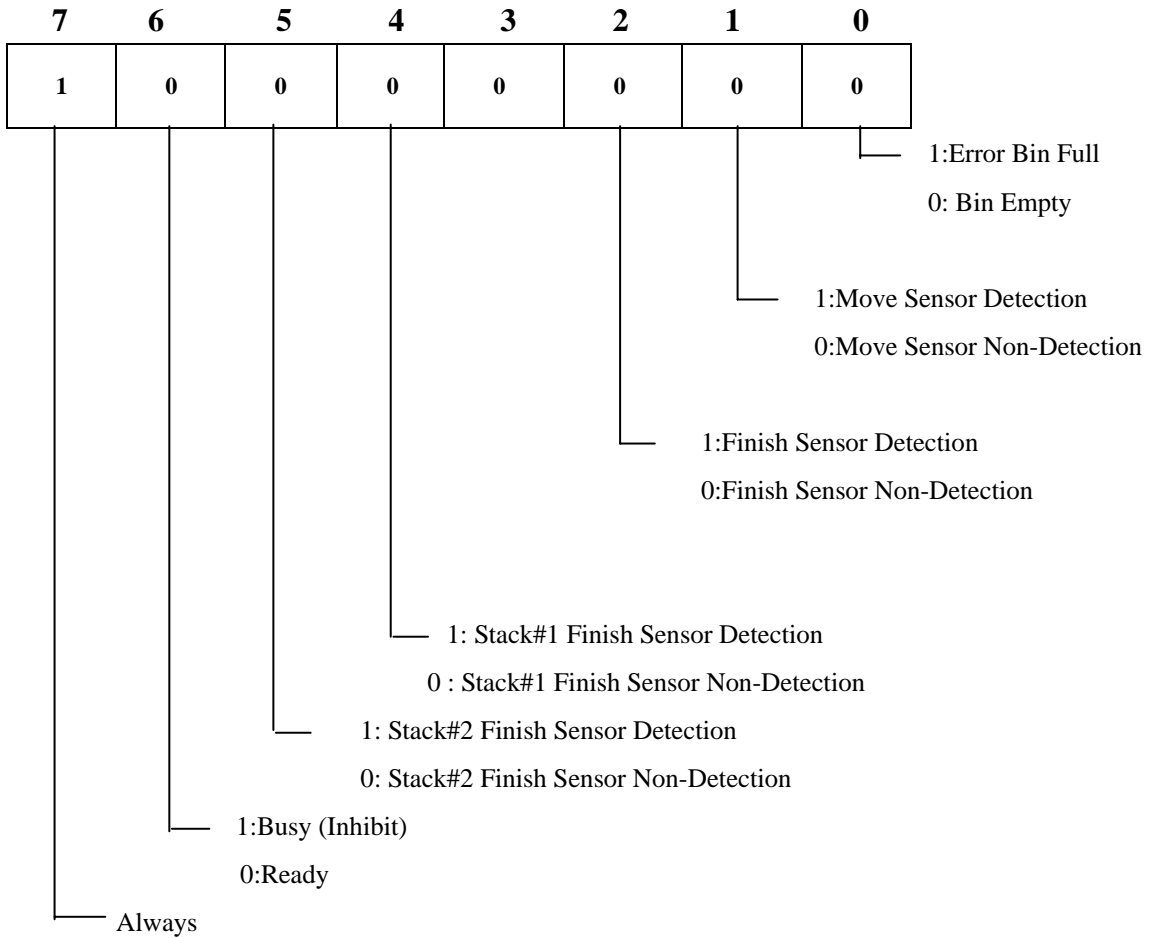

Doc No	KYT20XXSeries SPECIFICATION	REV	PAGE	DATE
		F	11 OF 27	2006. 10.30.

< ST 2 Format >

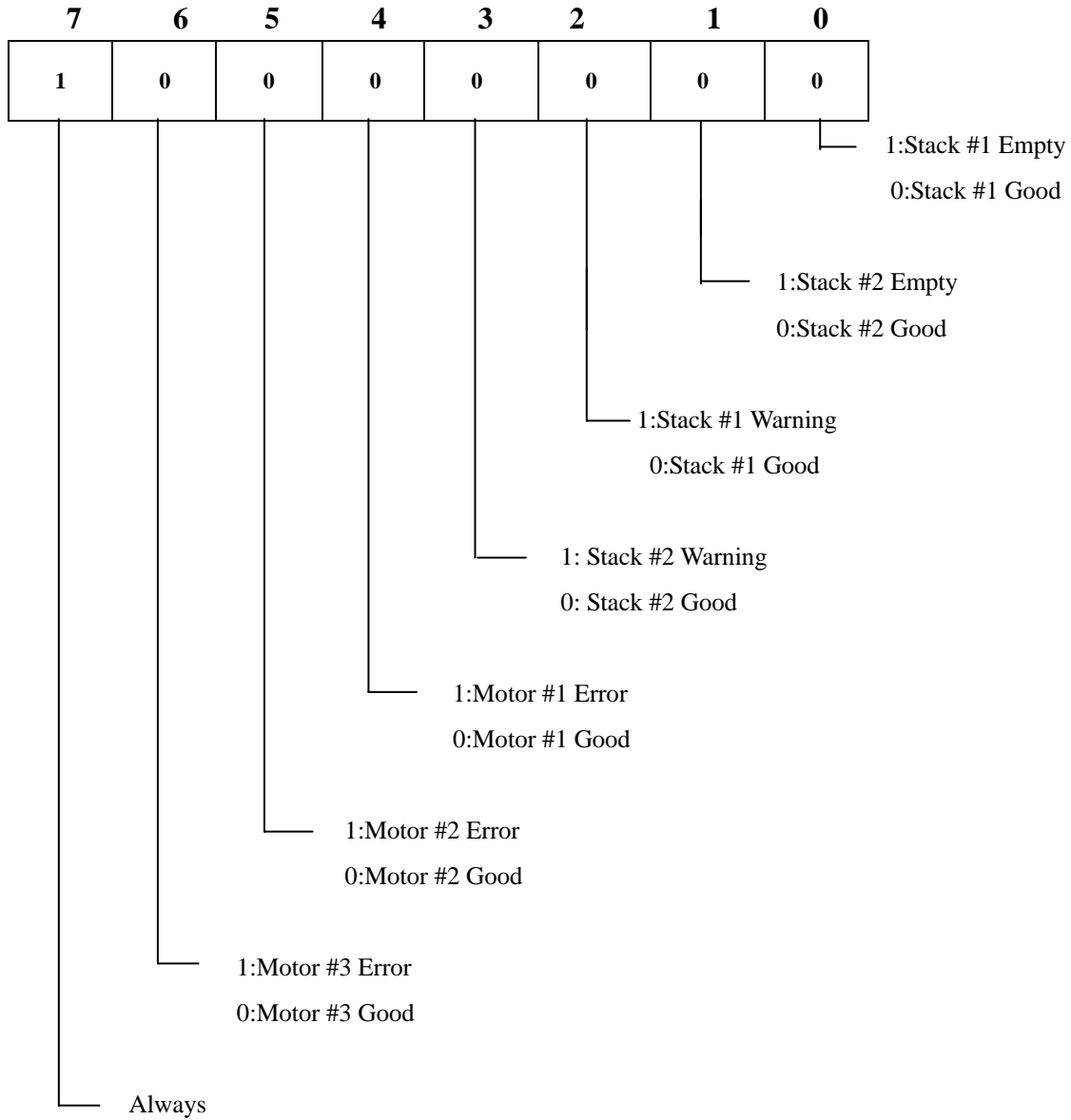

Doc No	KYT20XXSeries SPECIFICATION	REV	PAGE	DATE
		F	12 OF 27	2006. 10.30.

- Stacker #1 Warning, Stacker #2 Card Loading Low Warning
 - When the quantity of 0.76mm card goes below 20 cards , the Low Warning is signaled.
 - * Card Low Warning Sensors Locations
 - (User can change the location as he likes)
 - High : in case of less than 60 cards
 - Middle : in case of less than 40 cards
 - Low : in case of less than 20 cards (fixed in production line)
- Stacker # 1 Card Empty , Stacker # 2 Card Empty Warring
 - There is no card loaded or card completely dispensed out.
- Motor #1 Error, Motor #2 Error, Motor #3
 - Motor Fail, Card Jam, Sensor Error in operation
- Busy : Busy signal is detected only when it is in operation.
- Finish Sensor Detection : a status, in which a card is detected by finish sensor.
Finish Sensor Non-Detection : a status ,in which a card is not detected by finish sensor.
- Move Sensor Detection : a status, in which a card is detected by move sensor.
Move Sensor Non-Detection : a status, in which a card is not detected by move sensor.
- Error CARD Bin Full : When error card is over 20 cards in the bin , Error card bin full is signaled.
Bin Empty : in case captured card is less than 20 cards in the bin.
- * For information on sensors locations, refer to Page.25

Doc No	KYT20XXSeries SPECIFICATION	REV	PAGE	DATE
		F	13 OF 27	2006. 10.30.

6.2. Transmission Control Characters

Name	Hex Value	Description
STX	02	Character showing the start of text for the Command or Response .
ETX	03	Character showing the end of text for the Command or Response . Next character must be LRC
ENQ	05	Enquiry – Used to obtain an immediate status response.
ACK	06	Acknowledge – LRC correct. Command executed
NAK	15	Negative Acknowledge – LRC Error. Retransmit packet.
CAN	18	Issuing Command is not executed if it is transmitted while Dispenser is under operation

- 6.3. Character Format :
- Data bit - 8 bit
 - Stop bit - 1 bit
 - Parity bit - None
 - Baud Rate - 9600(default)

7. Protocol

7.1. Enquiry

Example)

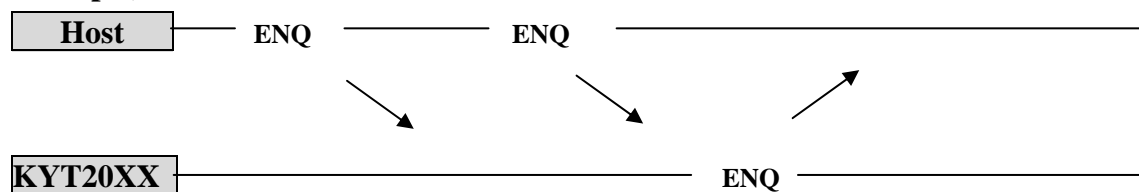

Error signal is sent if there is no response after Host transmits ENQ 3 times.

Doc No	KYT20XXSeries SPECIFICATION	REV	PAGE	DATE
		F	14 OF 27	2006. 10.30.

7.2 General Sequence

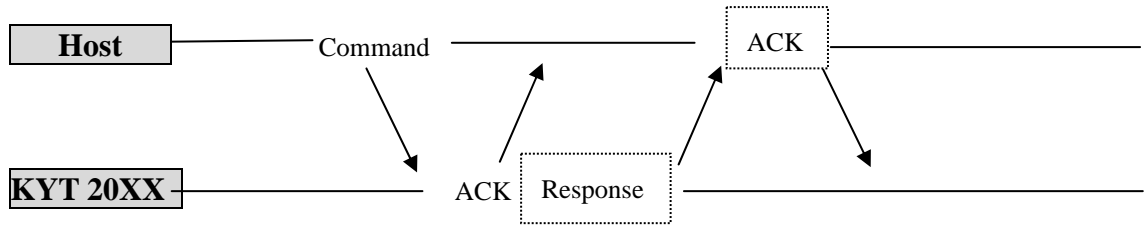

There are 2 types of sequence. In general, when command received, KYT-20XX checks command and sends ACK. Then, KYT-20XX runs , and as soon as Command executed, it receives ACK after transmitting Response . In another sequence, as soon as KYT-20XX receives Command , it transmits ACK and starts to run ,but it does not send Response.

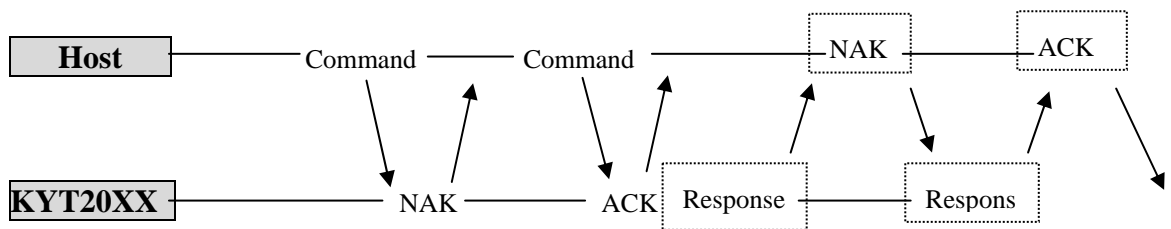

Above is reference sequence in case of the transmission and the sending of abnormal Commands and Responses.

Doc No	KYT20XXSeries SPECIFICATION	REV	PAGE	DATE
		F	15 OF 27	2006. 10.30.

7.3. RS-232C Control Command

In case of RS-232C interface, Function Commands are executed by Command Code as below table.

NO	Hex Value	Function
1	0x30	Clear
2	0x31	Status Request
3	0x40	Stacker #1 Out
4	0x41	Stacker#2 Out
5	0x42	Auto Issue
6	0x43	Capture
7	0x44	Feed In
8	0x45	Feed Out
9	0x46	Stop
10	0x47	Stack1 Wait
11	0x48	Stack2 Wait
12	0x49	Auto Wait
14	0x4a	Feed Out Sol
13	0x50	9600 bps set (default)
14	0x51	19,200 bps set
15	0x60	Version

7.3.1 Function

- ◆ CLEAR : Initializing parameters .

Ex) Initialize Error Bit.

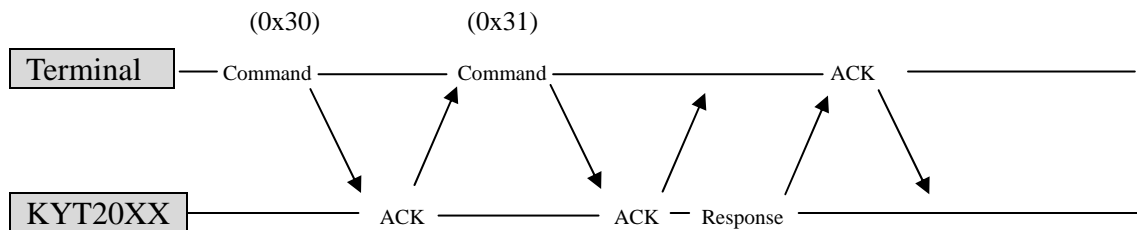

“ STX” Command only can be used without sending “ ENQ “ part for communication . If Clear Command (0x30) is transmitted , KYT-20XX just sends ACK as a Response . To check if Dispenser is cleared , send Status Request Command (0x31)

Doc No	KYT20XXSeries SPECIFICATION	REV	PAGE	DATE
		F	16 OF 27	2006. 10.30.

- ◆ Status Request : Host's request for Status of Dispenser

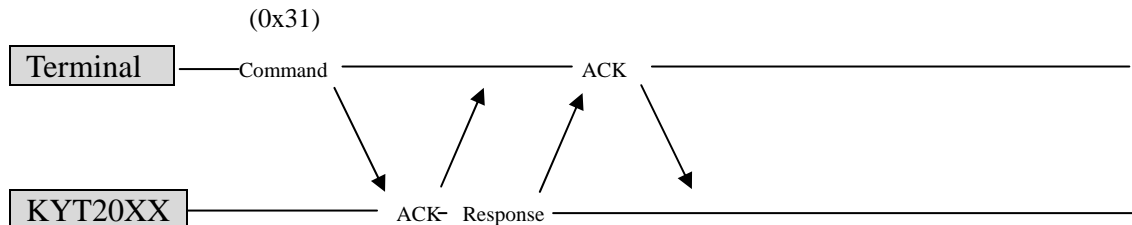

When Command(0x31) is transmitted , ACK & Response are transmitted to Terminal .

- ◆ Stacker #1 Out : Issue card from Stacker #1

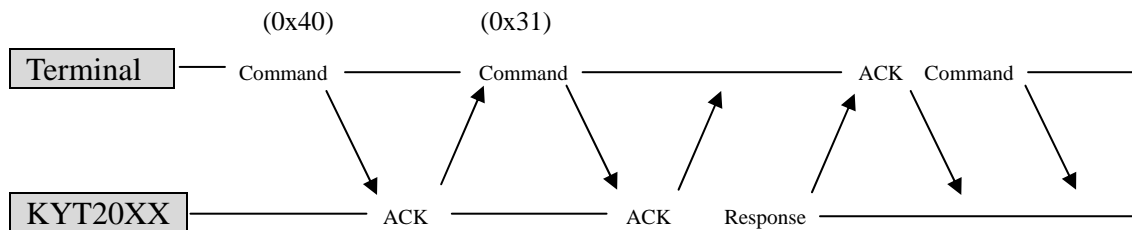

When Command(0x40) is transmitted , KYT-20XX sends ACK only , but does not send Response . So, able to check if Dispenser operates well by sending Status Request Command (0x31) .Check Status until Busy Flag of ST 1(1 Byte) in Response becomes 0 .

If User wants to have card stop at a point where he want after moving card by Stacker # 1 Out Command(0x40) ,send Stop Command (0x46) . Don't send Stop Command (0x46) while Motor # 1 is in running . If Stop Command was sent, transmit Feed Out Command (0x45) to move card out .

To take card back to Bin Box(i.e, capture card) , send Capture Command (0x43) or Feed In Command(0x44) .

Doc No	KYT20XXSeries SPECIFICATION	REV	PAGE	DATE
		F	17 OF 27	2006. 10.30.

- ◆ Stacker # 2 Out : Issue card from Stacker # 2

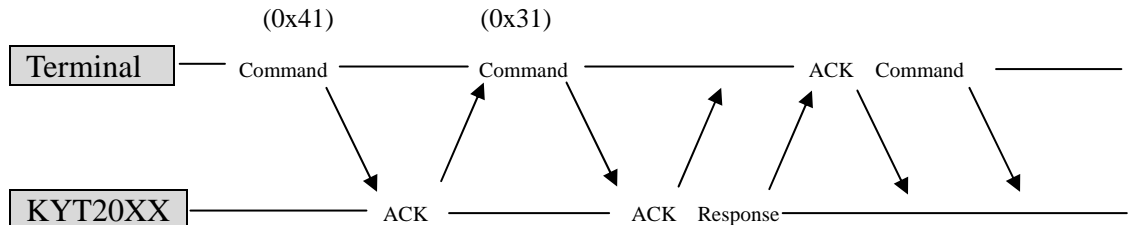

When Command(0x40) is transmitted , KYT-20XX sends ACK only , but does not send Response . So, able to check if Dispenser operates well by sending Status Request Command (0x31) . Check Status until Busy Flag of ST 1(1 Byte) in Response becomes 0 .

If User wants to have card stop at a point where he want after moving card by Stacker # 2 Out Command(0x41) ,send Stop Command (0x46) . Don't send Stop Command (0x46) while Motor # 1 is in running . If Stop Command (0x46) was sent, transmit Feed Out Command (0x45) to move card out .

To take card back to Bin Box(i.e, capture card) , send Capture Command (0x43) or Feed In Command(0x44) .

- ◆ Auto Out : If cards are in both Stacker # 1 and Stacker # 2 , card dispensing starts from Stacker # 1 . If Stacker # 1 is empty , card dispensing starts from Stacker # 2 . If cards are put in Stacker # 1 while Stacker # 2 runs with Stacker # 1 empty , card dispensing switches to Stacker # 1 .

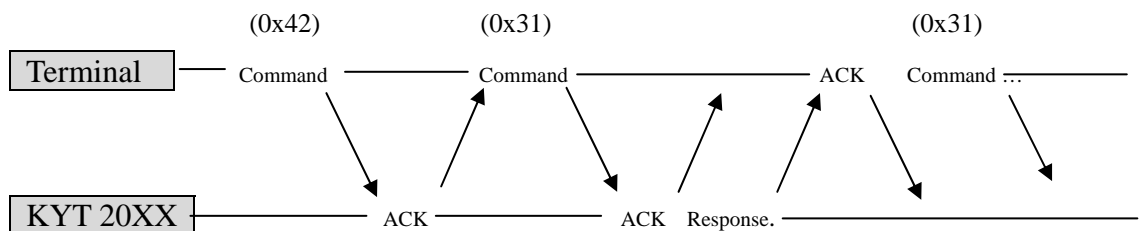

When Command(0x40) is transmitted , KYT-20XX sends ACK only , but does not send Response . So, able to check if Dispenser operates well by sending Status Request Command (0x31) . Check Status until Busy Flag of ST 1(1 Byte) in Response becomes 0 .

If User wants to have card stop at a point where he want after moving card by Auto Issue Command(0x42) ,send Stop Command (0x46) . Don't send Stop Command (0x46) while Motor # 1 is in running . If Stop Command(0x46) was sent, transmit Feed Out Command (0x45) to move card out .

To take card back to Bin Box(i.e, capture card) , send Capture Command (0x43) or Feed In Command(0x44) .

Doc No	KYT20XXSeries SPECIFICATION	REV	PAGE	DATE
		F	18 OF 27	2006. 10.30.

- ◆ Capture : Make Motor # 3 run backward to take card back to Bin Box .

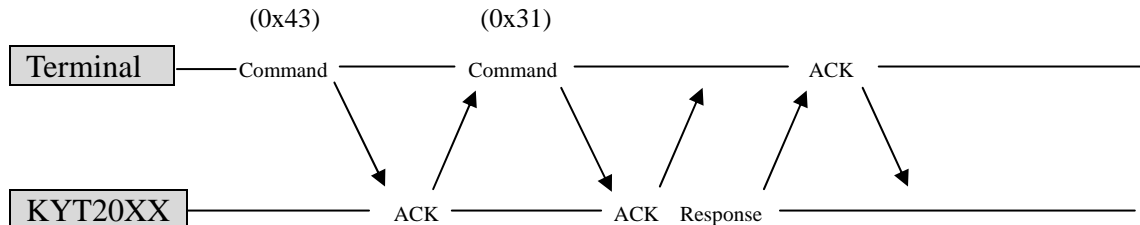

If Capture Command (0x43) is transmitted , Motor#3 starts to run . If card is not detected in 3000ms , this operation stops . If this Command is transmitted, it is counted that how many cards are captured. In case Feed In command is sent, card is sent back to Bin Box , but the card is NOT counted .

- ◆ Stacker#1 Wait : If a card is completely sent our from Stacker # 1 , a card from Stacker # 1 moves to Move Sensor .

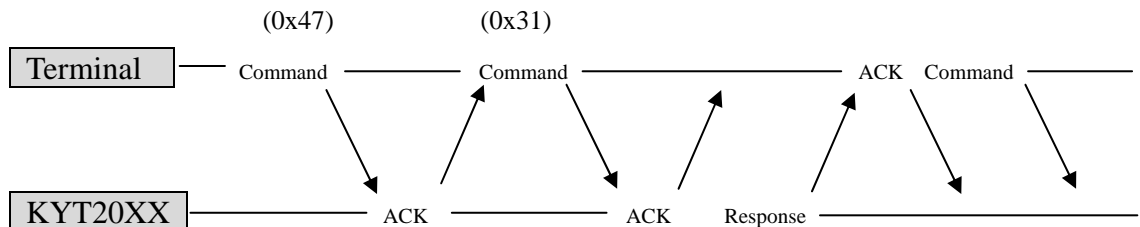

When Command(0x47) is transmitted , KYT-20XX sends ACK only , but does not send Response . So, able to check if Dispenser operates well by sending Status Request Command (0x31) .Check Status until Busy Flag of ST 1(1 Byte) in Response becomes 0 .

If User wants to have card stop at a point where he want after moving card by Stacker # 1 Out Command(0x40) ,send Stop Command (0x46) . Don't send Stop Command (0x46) while Motor # 1 is in running . If Stop Command was sent, transmit Feed Out Command (0x45) to move card out .

To take card back to Bin Box(i.e, capture card) , send Capture Command (0x43) or Feed In Command(0x44) .

Doc No	KYT20XXSeries SPECIFICATION	REV	PAGE	DATE
		F	19 OF 27	2006. 10.30.

◆ Stacker # 2 Wait : If a card is completely sent out from Stacker # 2 , a card from Stacker # 2 moves to Move Sensor .

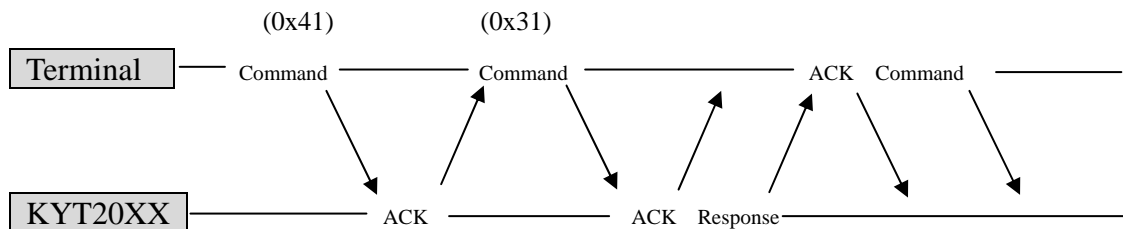

When Command(0x49) is transmitted , KYT-20XX sends ACK only , but does not send Response . So, able to check if Dispenser operates well by sending Status Request Command (0x31) . Check Status until Busy Flag of ST 1(1 Byte) in Response becomes 0 .

If User wants to have card stop at a point where he want after moving card by Stacker # 2 Out Command(0x41) ,send Stop Command (0x46) . Don't send Stop Command (0x46) while Motor # 1 is in running . If Stop Command (0x46) was sent, transmit Feed Out Command (0x45) to move card out .

To take card back to Bin Box(i.e, capture card) , send Capture Command (0x43) or Feed In Command(0x44) .

◆ Auto Wait : It is the same function as Auto Out . A card moves to Move Sensor.

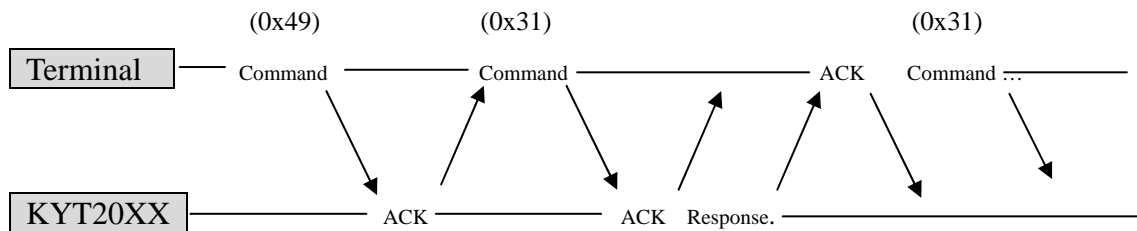

When Command(0x49) is transmitted , KYT-20XX sends ACK only , but does not send Response . So, able to check if Dispenser operates well by sending Status Request Command (0x31) . Check Status until Busy Flag of ST 1(1 Byte) in Response becomes 0 .

If User wants to have card stop at a point where he want after moving card by Auto Issue Command(0x42) ,send Stop Command (0x46) . Don't send Stop Command (0x46) while Motor # 1 is in running . If Stop Command(0x46) was sent, transmit Feed Out Command (0x45) to move card out .

To take card back to Bin Box(i.e, capture card) , send Capture Command (0x43) or Feed In Command(0x44) .

Doc No	KYT20XXSeries SPECIFICATION	REV	PAGE	DATE
		F	20 OF 27	2006. 10.30.

* Note

If over 20 cards are captured to Bin Box , it causes error Bin Full . If error Bin Full happens ,remove cards from Bin Box . Otherwise , an error happens .

- ◆ Stop : A command to position a card at a location User likes.

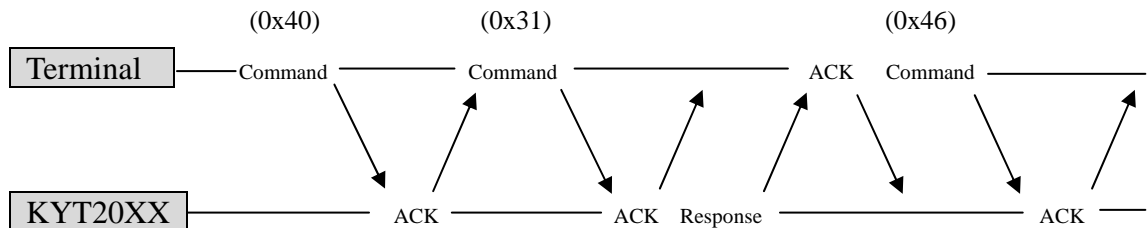

- ◆ Feed In : Make Motor # 3 run backward to take card back to Bin Box .

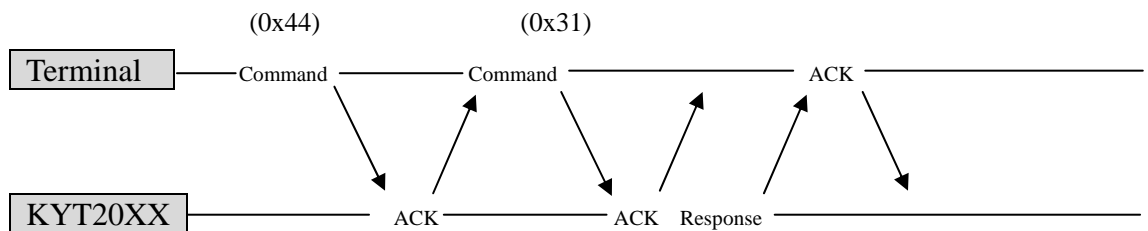

If Feed In Command (0x44) is transmitted , Motor#3 starts to run . If card is not detected in 3000ms , this operation stops .

There is no difference between Capture Command (0x43) and Feed In Command . Either Capture Command or Feed In Command can be used .

- ◆ Feed Out : A card is sent out when the card is detected by Finish Sensor.

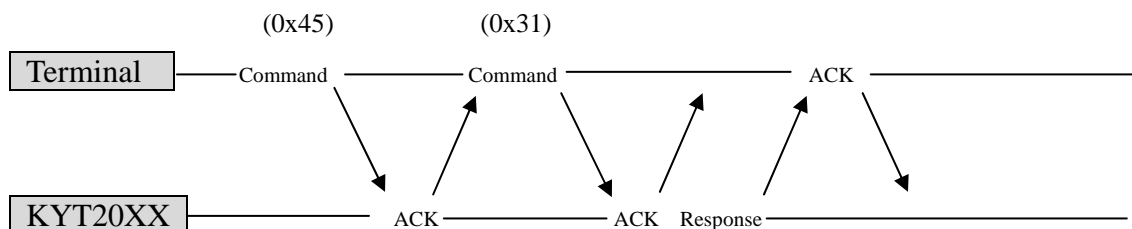

When Feed Out Command(0x45) is transmitted , Motor # 3 runs . If card is not detected in 3000ms , this operation stops . Use this Command to move card out ,which is on Move Sensor , Finish Sensor .

Doc No	KYT20XXSeries SPECIFICATION	REV	PAGE	DATE
		F	21 OF 27	2006. 10.30.

◆ Feed Out Sol : If a card stays at Move Sensor or between Move Sensor and Finish Sensor , this Command forces the card to be dispensed . (it runs for 0.2 seconds , and then the card moves)

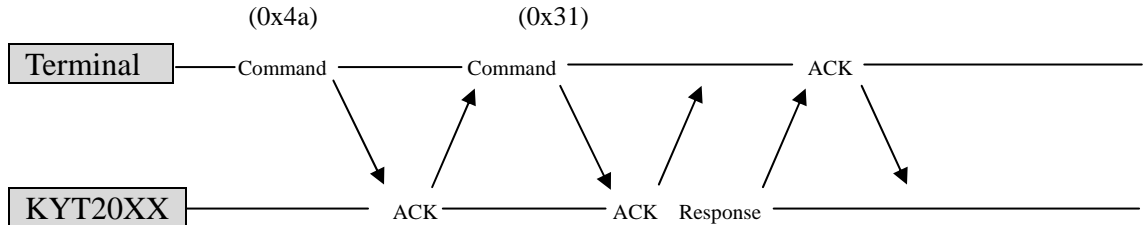

If Feed In Command (0x44) is transmitted , Motor#3 starts to run . If card is not detected in 3000ms , this operation stops .

If it is in the state that the card is sensed by Finish Sensor , it does not operate.

※ Note – It stops operating if the card is not detected by Finish Sensor 2 seconds after Feed Out Sol Command makes Motor # 3 start to run .

◆ Baud Rate Control Command

1	0x50	9,600 bps (default)
2	0x51	19,200 bps

To speed up transmission , send Command(0x51) .

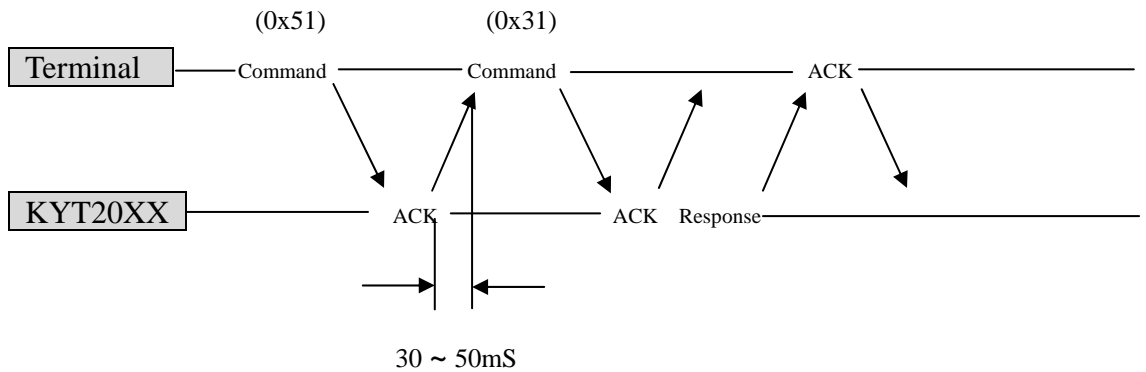

Ex)

STX	0x51	ETX	LRC
-----	------	-----	-----

 : 19,200 bps set

Doc No	KYT20XXSeries SPECIFICATION	REV	PAGE	DATE
		F	22 OF 27	2006. 10.30.

◆ VERSION : It indicates Firmware Version .

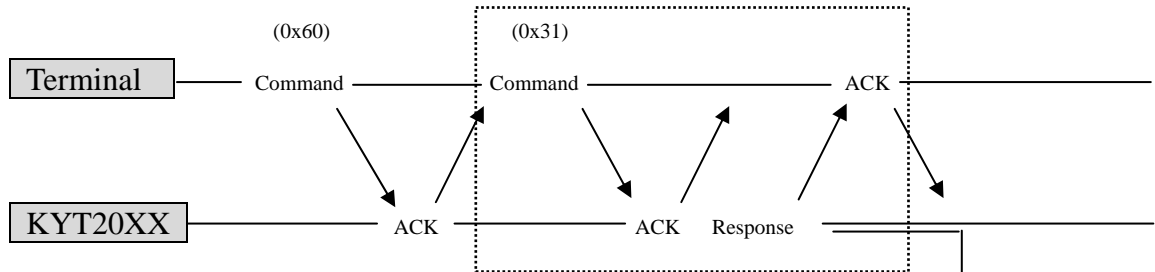

Ex) In case Firmware Version is 2.0

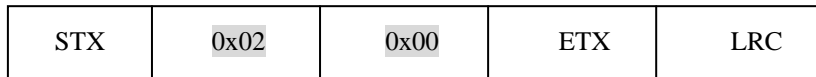

As Firmware version is not checked by sending Command (0x60) , Status Command should be sent thereafter. Then , User gets Firmware version .

주의) Response to Status Request(0x31) following Command (0x60) is Firmware Versions , and Response to the next Status Request is about Dispenser .

7.4 Response Timing

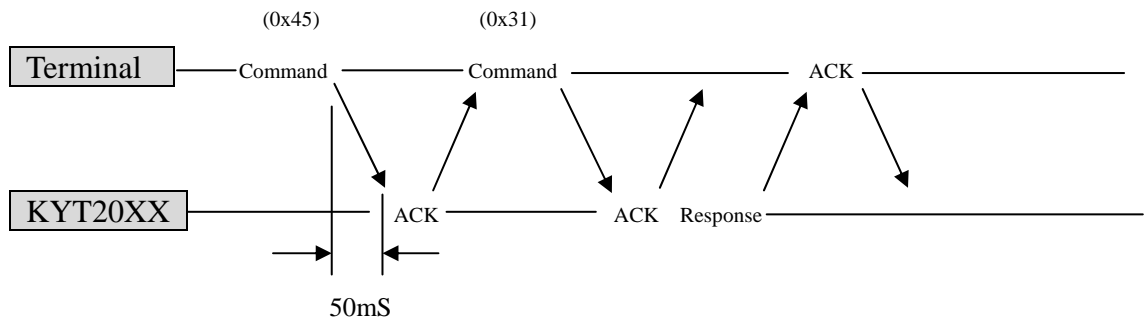

All of Command should Be sent from Host to KYT-20XX within 50ms time duration .

Doc No	KYT20XXSeries SPECIFICATION	REV	PAGE	DATE
		F	23 OF 27	2006. 10.30.

8. Technical Drawing.

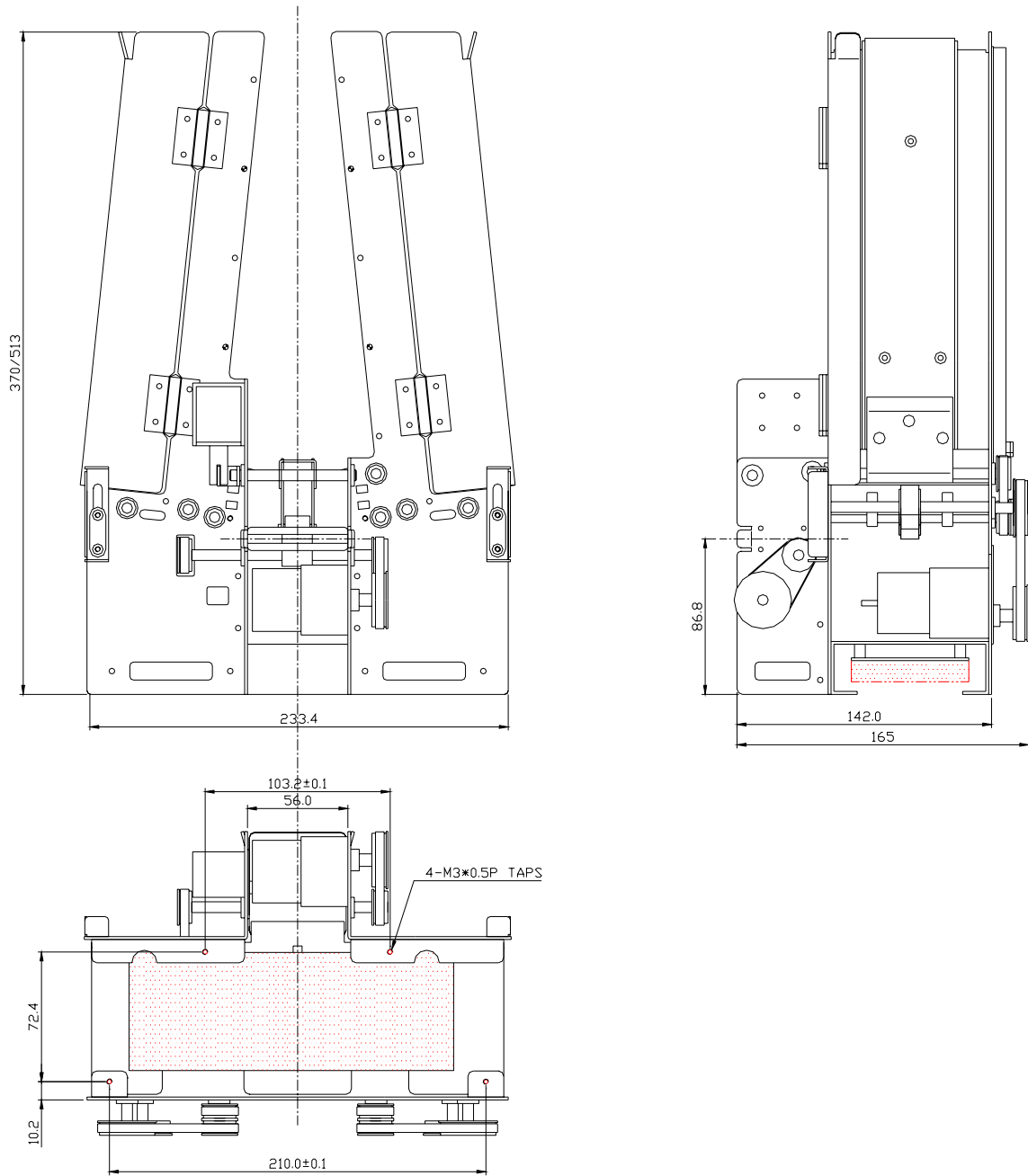

Doc No	KYT20XXSeries SPECIFICATION	REV	PAGE	DATE
		F	24 OF 27	2006. 10.30.

Dispenser Start-Up Setting

1) In case of RS232C Interface

1. Connect DC Power Connector (J3)
2. Connect RS 232C Connector(J2)
3. Load cards onto Stacker # 1 and Stacker # 2.
4. Put weight on top of cards in each Stacker.
5. Power On.
6. Transmit command to operate Dispenser.

Doc No	KYT20XXSeries SPECIFICATION	REV	PAGE	DATE
		F	25 OF 27	2006. 10.30.

TROUBLE SHOOTING

< Problem & Symptom >

- KYT20XX does not initialize.

< Check >

- When it is Power on

- 1) Check if Motor #1 and Motor #2 run.
- 2) Check if LEDs on Main board is on.

<First Aid >

- 1) Check if DC Power Connector (J3) is connected. Ex) Page 6
- 2) Check what power voltage is supplied, then connect Power connector. Ex) Page 6
See KYT20XX Main board to locate where J3 is.

<< Sensors' Problems & Symptoms >>

< Problem & Symptom >

.When Stacker#1 Out(Command:0x40) is sent , Motor of Stacker#1 starts to run. Then, 3 to 4 cards comes out of Stacker#1 , moving to Move sensor.

< First Aid >

Check out Finish sensor # (J4) of Stacker#1 and its connector.

Put a card on Finish sensor of Stacker # 1 , and check if its connector voltage is Low. If it is not Low, Replace Finish sensor of Stacker # 1.

Doc No	KYT20XXSeries SPECIFICATION	REV	PAGE	DATE
		F	26 OF 27	2006. 10.30.

<Problem & Symptom>

When Stacker # 1 Out (Command : 0x40) is sent, Stacker # 1 does not run at all.

< First Aid>

Check out Stacker # 1 Micro S/W sensor(J5) and its connector connected to Main board.

Put a card on Stacker # 1 Micro S/W sensor, and check out if Connector voltage is Low. If it is not Low, replace Micro S/W with new one.

< Problem & Symptom >

When Stacker # 1 Out (Command : 0x40) is sent , Motor of Stacker # 1 starts to run, making card being dispensed. Low Warning Sensor on Stacker # 1 detects Weight in Stacker # 1 , but does not send Stacker # 1 Low Warning.

< First Aid >

Check out Stacker # 1 Sensor (J6) and its connector connected to Main board. While making Stacker # 1 Low Warning Sensor detect Weight , check if connector voltage is Low. If it is not Low, replace Stacker # 1 Low Warning Sensor with new one.

< Problem & Symptom >

When Capture (Command : 0x43) is sent, Motor # 3 starts to run. When a card is inserted to Finish Sensor, the card moves back to Bin box. Error Bin Box Full signal does not occur in spite there are 20 cards in the box.

<First Aid>

Check out Bin Empty Sensor (J8) and its connector connected to Main board. Check if Connector voltage is Low while a card is not detected by Bin sensor before Capture command (Command : 0x43) is sent. Or, check if Connector voltage is High while a card is detected. If it is not Low or High , replace Bin Empty Sensor with new one.

<Problem & Symptom>

A card comes out from Stacker ,moving to Move Sensor, but Motor # 3 and Solenoid does not start to run.

< First Aid >

Check Move Sensor (J9) and its connector connected to Main board. Check if Connector voltage is High while a card is detected by Move Sensor. If it is not High, replace Move Sensor with new one .

Doc No	KYT20XXSeries SPECIFICATION	REV	PAGE	DATE
		F	27 OF 27	2006. 10.30.

<Problem & Symptom >

.When Stacker#2 Out(Command:0x41) is sent , Motor of Stacker#2 starts to run. Then, 3 to 4 cards comes out of Stacker#2 , moving to Move sensor.

<First Aid>

Check out Finish sensor # (J10) of Stacker#2 and its connector.

Put a card on Finish sensor of Stacker # 2 , and check if its connector voltage is Low. If it is not Low, Replace Finish sensor of Stacker # 2.

<Problem & Symptom>

When Stacker # 2 Out (Command : 0x41) is sent, Stacker # 2 does not run at all.

<First Aid>

. Check out Stacker # 2 Micro S/W sensor(J11) and its connector connected to Main board.

Put a card on Stacker # 2 Micro S/W sensor, and check out if Connector voltage is Low. If it is not Low, replace Micro S/W with new one.

<Problem & Symptom>

When Stacker # 2 Out (Command : 0x41) is sent , Motor of Stacker # 2 starts to run, making card being dispensed. Low Warning Sensor on Stacker # 2 detects Weight in Stacker # 2 , but does not send Stacker # 2 Low Warning.

<First Aid>

Check out Stacker # 2 Warning Sensor (J12) and its connector connected to Main board. While making Stacker # 2 Low Warning Sensor detect Weight , check if connector voltage is Low. If it is not Low, replace Stacker # 2 Low Warning Sensor with new one.