

Doc No	CIS-2XXX SPECIFICATION	REV	PAGE	DATE
91000060		B	1 OF 57	2007. 10. 01.

Cartridge Card Issuing Station For Magnetic, Contact & IC Card

KYTronics Corp.,Ltd

3rd Floor, A-Dong,

Twin Town-Bldg, 703-2.

Gojan-Dong, AnSan-City,

Kyung Ki-Do, Korea

Tel : 82 - 31 - 485 - 9480

Fax : 82 - 31 - 485 - 9488

E-mail : sales@kytronics.co.kr

http://www.kytronics.co.kr

Doc No	CIS-2XXX SPECIFICATION	REV	PAGE	DATE
91000060		B	2 OF 57	2007. 10. 01.

REVISION HISTORY

No	DATE	DESCRIPTION	REV	PAGE	NOTE
1	2007. 07. 20.	Preliminary Version	X1	55	
2	2007 .08. 30	Revision-A Spec release	A	55	
3	2007 .10. 01	Technical Drawing added(CIS-26XX)	B	57	

Doc No	CIS-2XXX SPECIFICATION	REV	PAGE	DATE
91000060		B	3 OF 57	2007. 10. 01.

MODEL NAME INFORMATION

C I S - 2

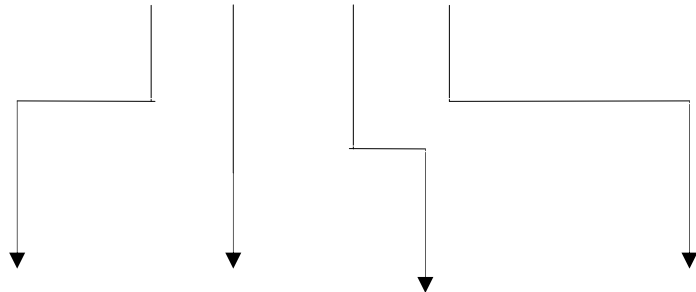

Interface	Function	MS / IC / RF	Track	Option	CAPACITY		
RS-232C	Single Cartridge & Single Cartridge Collector	0 : -	0 : Without Magnetic	0 : -	A: 0.2	G: 0.2	M: 0.2
		1 : MS Only	1 : ISO 1 Track	1: LOW-CO	B: 0.38	H: 0.38	N: 0.38
		2 : MS & IC-Contact	2 : ISO 2 Track	2: HI-CO	C: 0.5	I: 0.5	O: 0.5
		3 : MS & RF	3 : ISO 3 Track		D: 0.76	J: 0.76	P: 0.76
		4 : MS & IC & RF	4 : ISO 1,2 Track		E: 0.84	K: 0.84	Q: 0.84
		5 : IC-Contact Only	5 : ISO 1,3 Track		F: 1.0	L: 1.0	R: 1.0
		6 : RF Only	6 : ISO 2,3 Track				
7 : IC & RF	7 : ISO 1,2,3 Track				200 PCS	300 PCS	500PCS

Doc No	CIS-2XXX SPECIFICATION	REV	PAGE	DATE
91000060		B	4 OF 57	2007. 10. 01.

C O N T E N T S

Overview

System Block Diagram

Specification

Magnetic Card Process

IC Card Process

RF Card Process

Communication Interface

Technical Drawing

Command Detail

Error Detail

Precautions

Doc No	CIS-2XXX SPECIFICATION	REV	PAGE	DATE
91000060		B	5 OF 57	2007. 10. 01.

OVERVIEW

CIS-2XXX Series is a set of card issuing machine and collecting machine for the magnetic, IC, and RF card in conjunction with the KYT2500 and KYT3000 series and CMT-1010 series. This model can be used for magnetic card conforming to the ISO7816-2 standard and most of the IC cards conforming with the ISO7816-4 T=0,T=1. Additionally, this model also can be used for the RF card conforming to the MIFARE.

This model simplified the command for magnetic card, minimize the delay time occurs in the communication data processing, and improved the speed due to function to issue the all tracks at a time.

This model has the following advantages:

- 1) Remove the latency due to the user-based card exchange, by loading 500 PCS (0.76 mm card) at a time.
- 2) Automatic card collecting after data encoding.

As an automatic issuing station, this model can be used in issuing most types of credit card and debit card in financial area.

Doc No	CIS-2XXX SPECIFICATION	REV	PAGE	DATE
91000060		B	6 OF 57	2007. 10. 01.

SYSTEM BLOCK DIAGRAM

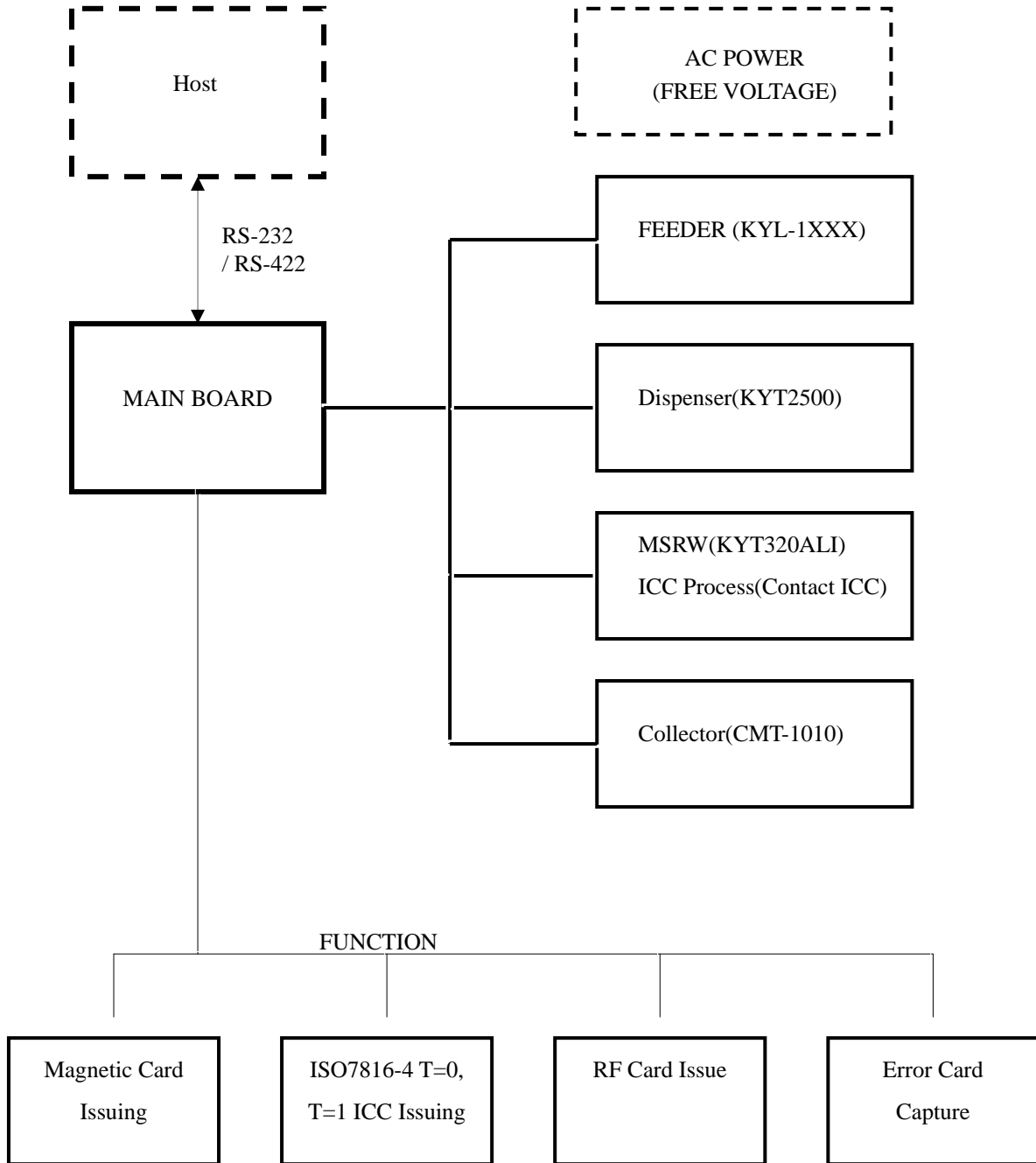

Doc No	CIS-2XXX SPECIFICATION	REV	PAGE	DATE
91000060		B	7 OF 57	2007. 10. 01.

◆ *RS – 232 Connection*

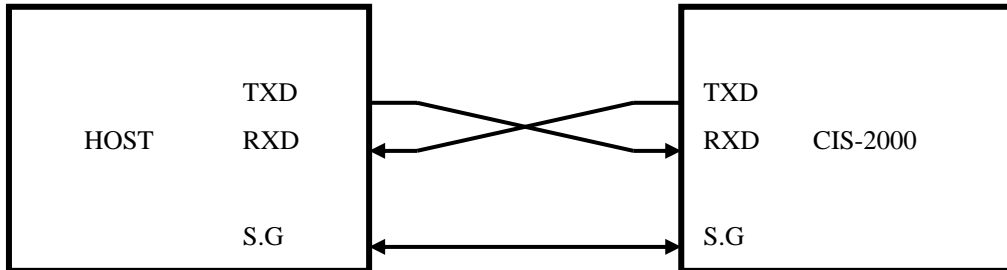

CASE 1) Part Number : D-SUB CONNECTOR(FEMALE)

Pin No	INDEX	Remark
2	RXD	Receive
3	TXD	Transmit
5	S.G	Signal Ground

◆ *RS422 Connection*

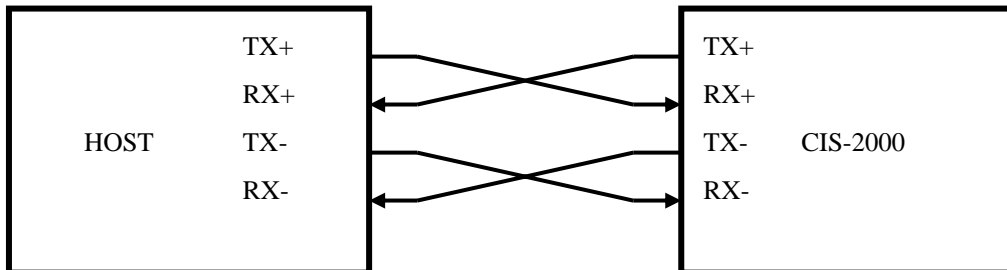

CASE 1) Part Number : D-SUB CONNECTOR(FEMALE)

Pin No	INDEX	Remark
1	TX+-	
4	RX+	
6	TX-	
8	RX-	

Doc No	CIS-2XXX SPECIFICATION	REV	PAGE	DATE
91000060		B	8 OF 57	2007. 10. 01.

SPECIFICATIONS

◆ *basic functions*

	Spec	Remark
Dimension	P19~20 Reference	
Weight		
Input power	Free Voltage (AC110~AC220)	

◆ *Environment Requirements*

Operating Locus : in door use Only

Ambient Temperature

Storage : -20 °C to 70 °C(No functional error to be found in 12 hours after returning to normal environment)

Operating : 5 °C to 50°C (In 0°C to +5°C range, all specifications but 'Warped card' to be satisfied)

Ambient Relative Humidity

Storage : 0% to 95% RH(No functional error to be found in 12 hours after returning to normal environment)

Operating : 5 % 90% RH(No Condensation)

Vibration

: Amplitude 2mm, 10 to 50 Hz in X, Y, Z directions for 30min, 2G or less

Shock Endurance

: 30G, 11ms

Encoding Speed : 2.3 ~ 5 Sec/Card

Life Time : More than 500,000card passes(1pass : one forward and backward)

Error Rate : Less than 3/1,000 cycle(Test Card : KYT Standard)

Doc No	CIS-2XXX SPECIFICATION	REV	PAGE	DATE
91000060		B	9 OF 57	2007. 10. 01.

◆ *Controller Environment*

Communication

- : RS422 OR RS232C Interface
- : Baud Rate – 9600 BPS
 - 19200 BPS
 - 38400BPS(Default)
 - 57600BPS
- : 8Data bit, 1 Start bit, None Parity bit, 1 Stop Bit

DIP-Switch Setting

: To provide basic operation and function setting of terminal, DIP(Dual In type Package) switch in the main board has selection of main program and function of communication speed setting.

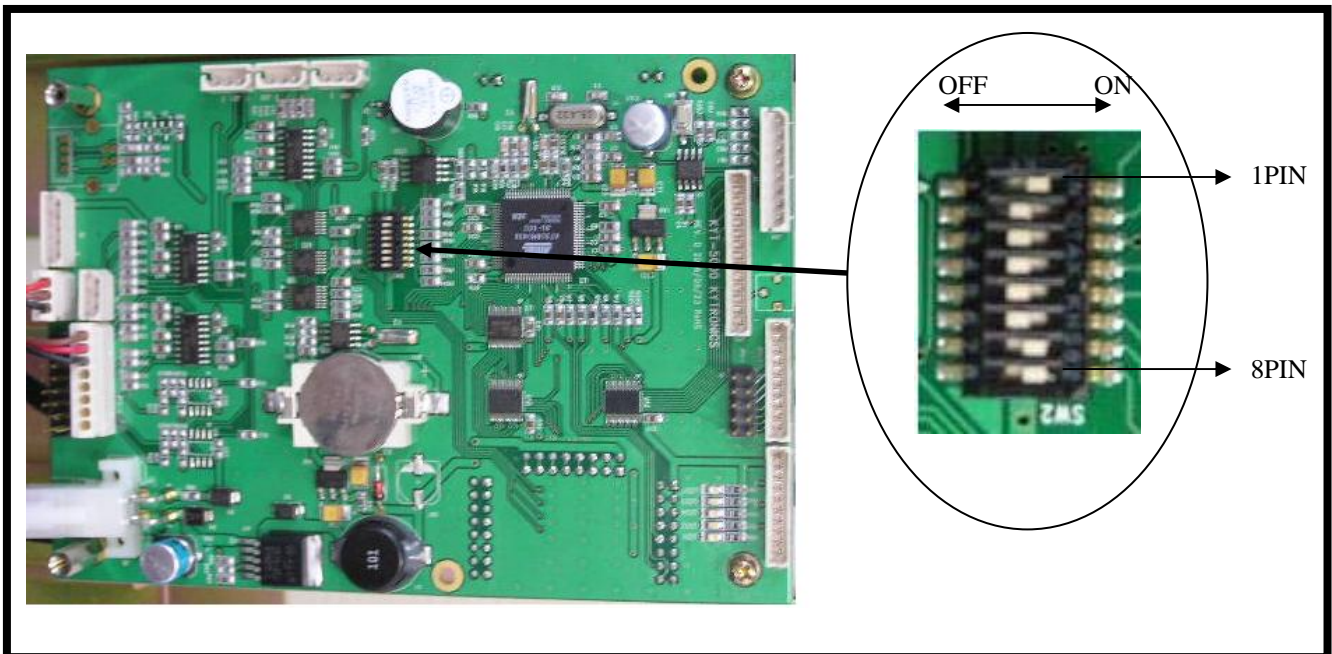

Pin No. 1	Pin No. 2~No. 6	Pin No. 7	Pin No. 8	Baud Rate	Note
ON	OFF	OFF	OFF	9600 BPS	
ON	OFF	OFF	ON	19200 BPS	
ON	OFF	ON	OFF	38400 BPS	Default
ON	OFF	ON	ON	57600 BPS	

Doc No	CIS-2XXX SPECIFICATION	REV	PAGE	DATE
91000060		B	10 OF 57	2007. 10. 01.

MAGNETIC CARD PROCESS

◆ *Total processing time*

: Less than 1.2 Sec

◆ *Life and Reliability*

Life of Head : Minimum 500,000 passes

(One pass is for forward and backward movement)

Error Rate : 5/1000 cycle

◆ *Reference Standards*

: ISO 7811-1,2,3,4,5 : identification cards – Recording technique

◆ *Recording*

	ISO Track 1	ISO Track 2	ISO Track 3
BPI	210	75	210
Capacity	Max 79	Max 40	Max 107
Reading Methods	F2F		
Length	Variable		
Card thickness	Plastic : 0.76 ±0.08mm		

Doc No	CIS-2XXX SPECIFICATION	REV	PAGE	DATE
91000060		B	11 OF 57	2007. 10. 01.

IC CARD PROCESS

This model provides most type of IC card compliant to ISO7816 T=0, T=1.

◆ *Processing time* : Less than 1 Sec

◆ *Number and Location of the contacts on IC Card*

: Number and location of the contacts on IC Card is specified in ISO 7816-2 figure 2
Refer to Appendix A.

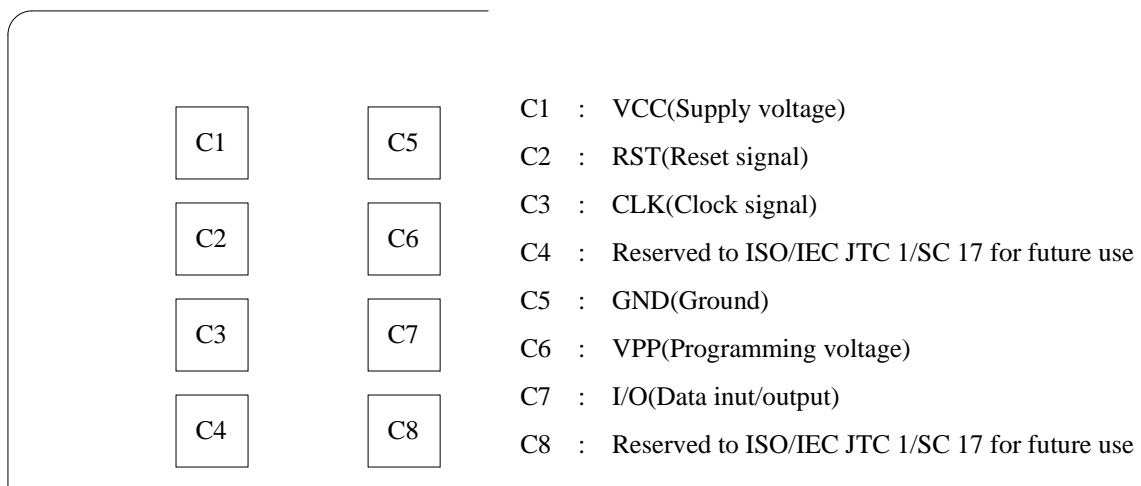

◆ *Power Consumption*

Motor Starting or Reversing : Less than 310mA(50mSec)
 Card Feed & Reading : Less than 690mA
 Card Feed & Writing : Less than 700mA
 Steady state : Less than 180mA

◆ *Life and Reliability*

IC Contact : Approximately 1,000,000 passes
 Error Rate : 3/1000 cycle

Doc No	CIS-2XXX SPECIFICATION	REV	PAGE	DATE
91000060		B	12 OF 57	2007. 10. 01.

RF CARD PROCESS

The RF module supports most of RF cards conforming with the ISO14443-3 TypeA(MIFARE Card) with 8 Kbits memory.

◆ *Processing time* : Once Block

Command	Parameter	Time (mSec)		Note
		Type	Max	
Card Read	1 Block	100		Without card moving
Card Write	1 Block	150		Without card moving, With Verify
Card Decrement	1 Block	120		Without card moving
Card Increment	1 Block	120		Without Card moving

◆ *Operating Frequency*

Operating Frequency : 13.56 MHz

Data Transfer Baud : Baud rate 106Kbaud

Doc No	CIS-2XXX SPECIFICATION	REV	PAGE	DATE
91000060		B	13 OF 57	2007. 10. 01.

COMMUNICATION INTERFACE

◆ *Communication Method*

Asynchronous, Half duplex.

Baud Rate : 9600 – 57600Bps , Default : 38400Bps

Start Bit : 1Bit

Data Length : 8Bit

Parity : None

Stop Bit : 1Bit

◆ *Communication Protocol Format*

1 Command Frame Format.

SOH	Null	Length	STX	CMD	DATA	ETX	BCC
1BYTE	1BYTE	2BYTE	1BYTE	3BYTE	N-BYTE	1BYTE	1BYTE

2 Positive Response Frame Format

SOH	Null	Length	STX	CMD	GOOD	0x01	DATA	ETX	BCC
1BYTE	1BYTE	2BYTE	1BYTE	3BYTE	1BYTE	1BYTE	N-BYTE	1BYTE	1BYTE

3 Negative Response Frame Format

SOH	Null	Length	STX	CMD	E-Code	0x00	ETX	BCC
1BYTE	1BYTE	2BYTE	1BYTE	3BYTE	2BYTE	1BYTE	1BYTE	1BYTE

4 BCC (Check Sum)

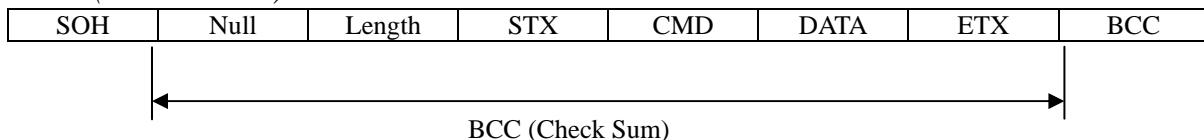

Command Frame BCC = Null ^ Length ^ STX ^ CMD ^ DATA ^ ETX.

Positive Response BCC = Null ^ Length ^ STX ^ CMD ^ GOOD ^ 0x01 ^ DATA ^ ETX.

Negative Response BCC = Null ^ Length ^ STX ^ CMD ^ E-Code ^ ETX.

N BYTE : Variable Length

Doc No	CIS-2XXX SPECIFICATION	REV	PAGE	DATE
91000060		B	14 OF 57	2007. 10. 01.

5. Explanatory note of technical words

Name	Detail
Null	Reserved. Always 0x00.
Length	Data Length from the CMD to DATA.
CMD	Instruction Code (3 Bytes)
GOOD	Normal Execution : 0x0000 (2 Bytes)
E-Code	Command Failed: Refer to "Error Code" (2 Bytes)
BCC	Check Sum.

<Length>, <E-Code>

High Byte	Low Byte
-----------	----------

6. Control Characters

Name	Hex Value	Detail
SOH	0x01	Start of Header
STX	0x02	Start of Text
ETX	0x03	End of Text
ENQ	0x05	Enquiry
ACK	0x06	Positive Acknowledge
NAK	0x15	Negative Acknowledge
CAN	0x18	Cancel

7 COMMUNICATION SEQUENCE / TIMING

7.1 CHARACTER GUIDE TIME

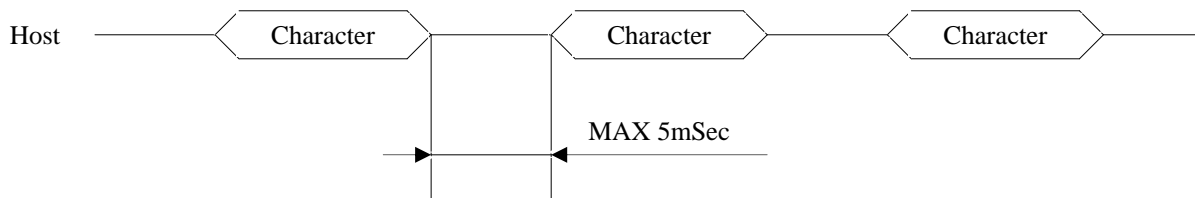

If no consecutive character within 5msec., do time out.

Doc No	CIS-2XXX SPECIFICATION	REV	PAGE	DATE
91000060		B	15 OF 57	2007. 10. 01.

7.2 SEQUENCE

7.2.1 General

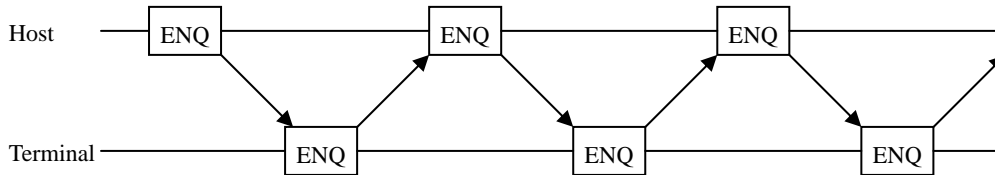
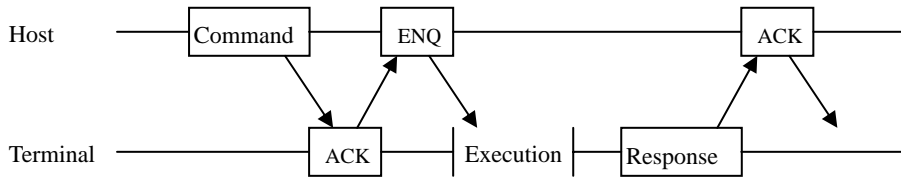

7.2.2 Error

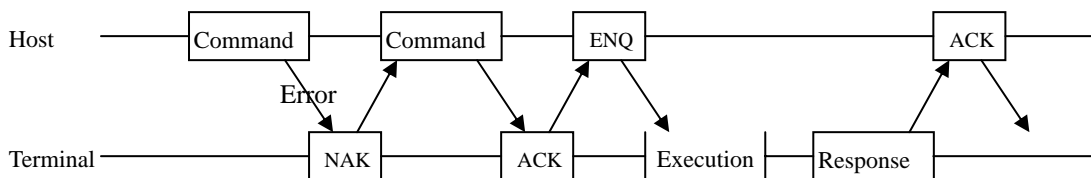
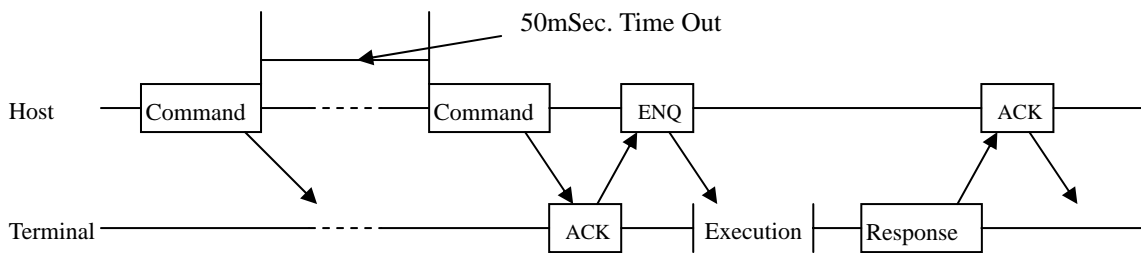

Doc No	CIS-2XXX SPECIFICATION	REV	PAGE	DATE
91000060		B	16 OF 57	2007. 10. 01.

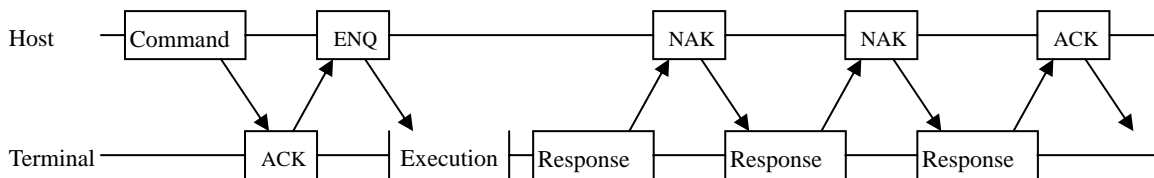
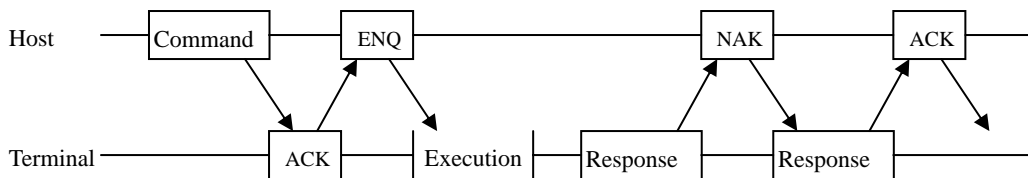
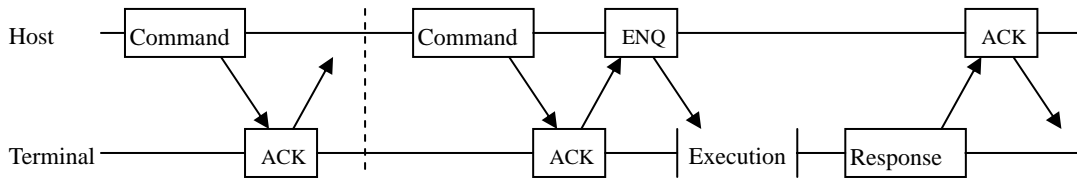
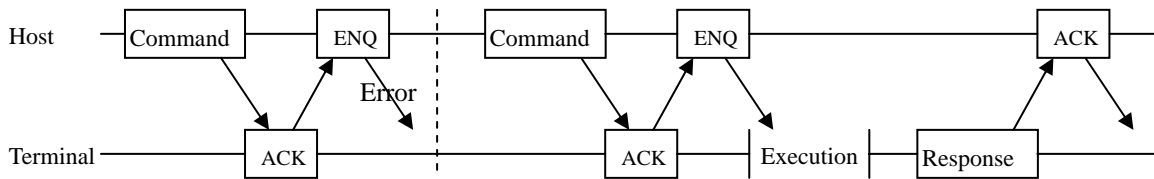
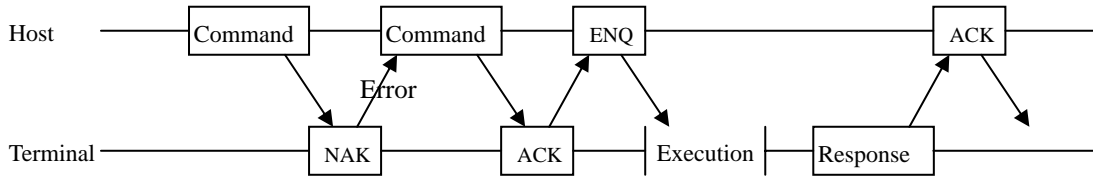

Doc No	CIS-2XXX SPECIFICATION	REV	PAGE	DATE
91000060		B	17 OF 57	2007. 10. 01.

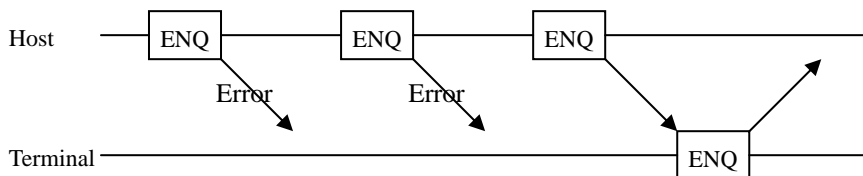
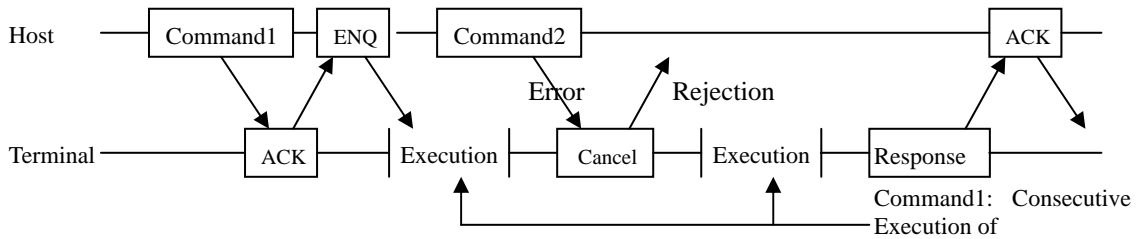
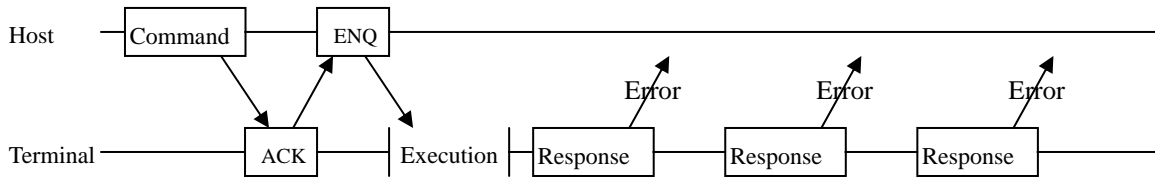
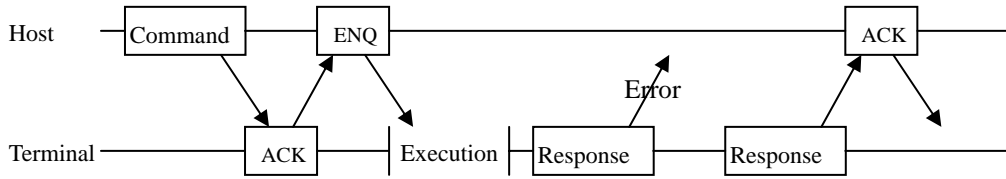
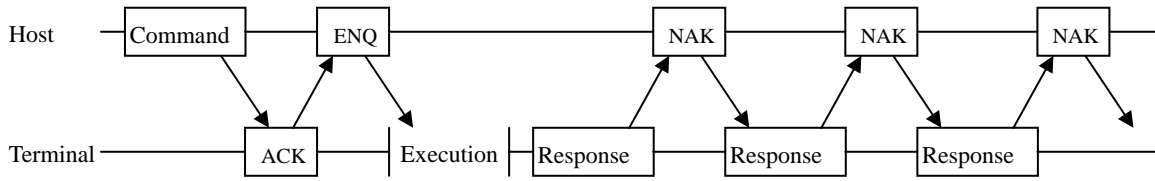

Doc No	CIS-2XXX SPECIFICATION	REV	PAGE	DATE
91000060		B	18 OF 57	2007. 10. 01.

- When received the NAK packet consecutively.

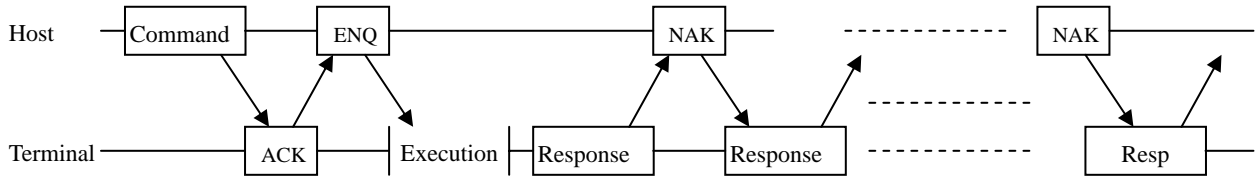

- When the Host sends the command without the ACK packet.

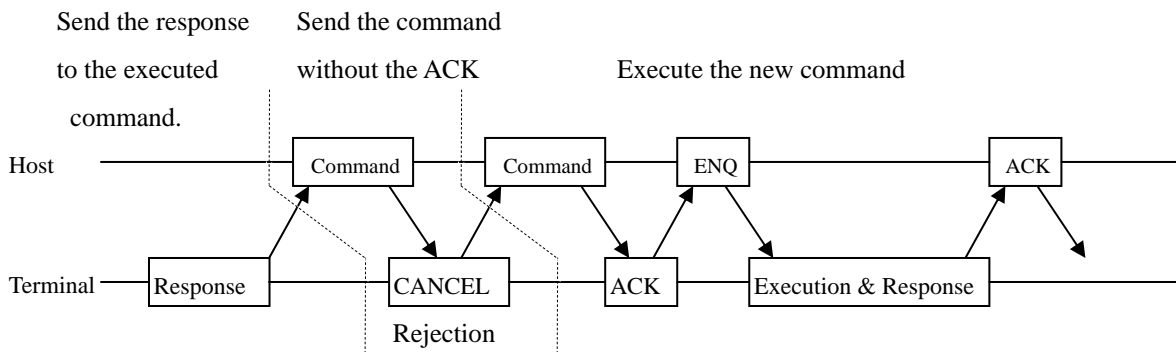

The terminal should ignore the command received before it sends the ACK packet, send the CANCEL packet. The second command will be treated as the ACK packet and executed with no ACK.

Doc No	CIS-2XXX SPECIFICATION	REV	PAGE	DATE
91000060		B	19 OF 57	2007. 10. 01.

TECHNICAL DRAWING

<CIS-21XX, CIS-22XX, CIS-23XX, CIS-24XX, CIS-25XX, CIS-27XX >

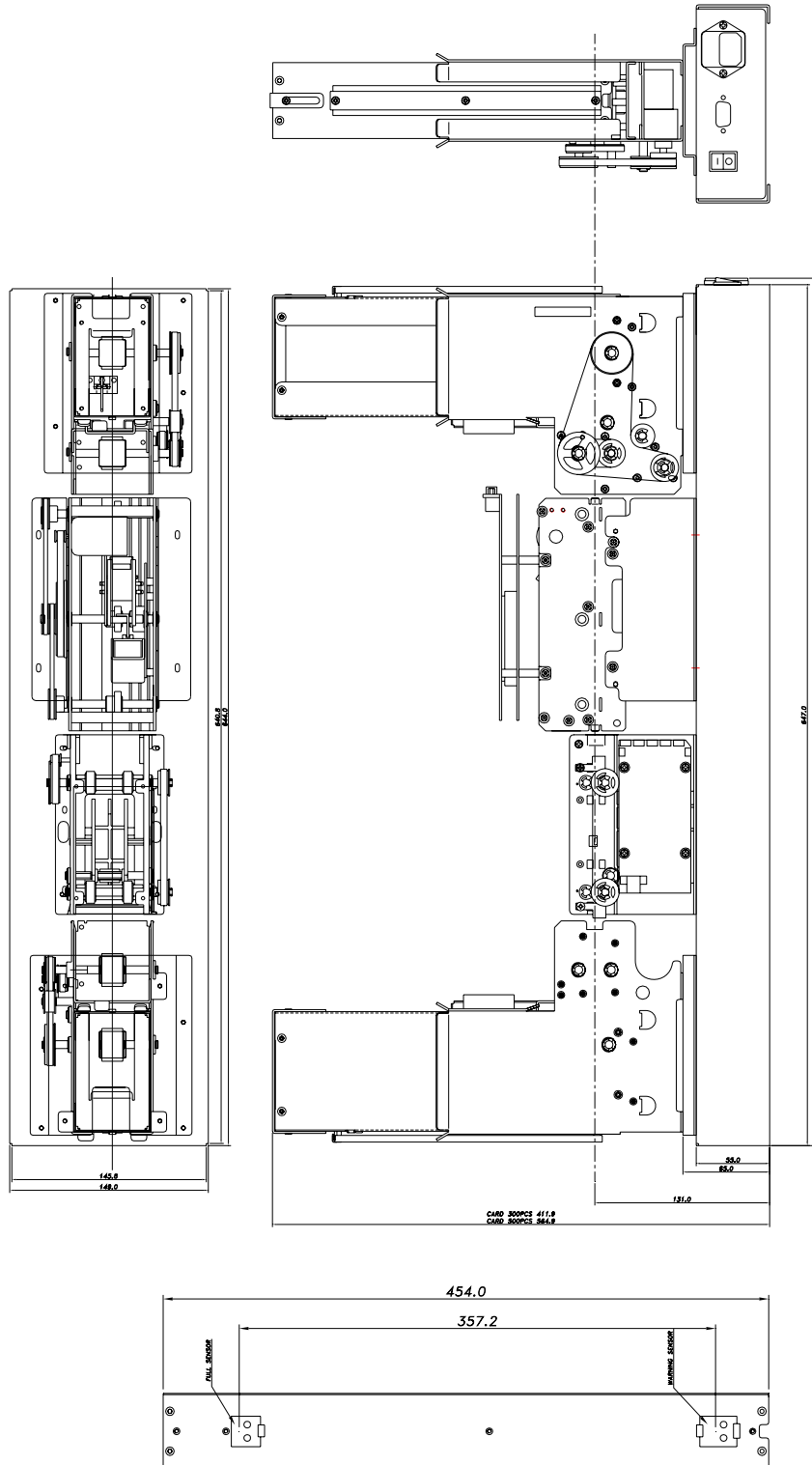

Doc No	CIS-2XXX SPECIFICATION	REV	PAGE	DATE
91000060		B	20 OF 57	2007. 10. 01.

<CIS-26XX>

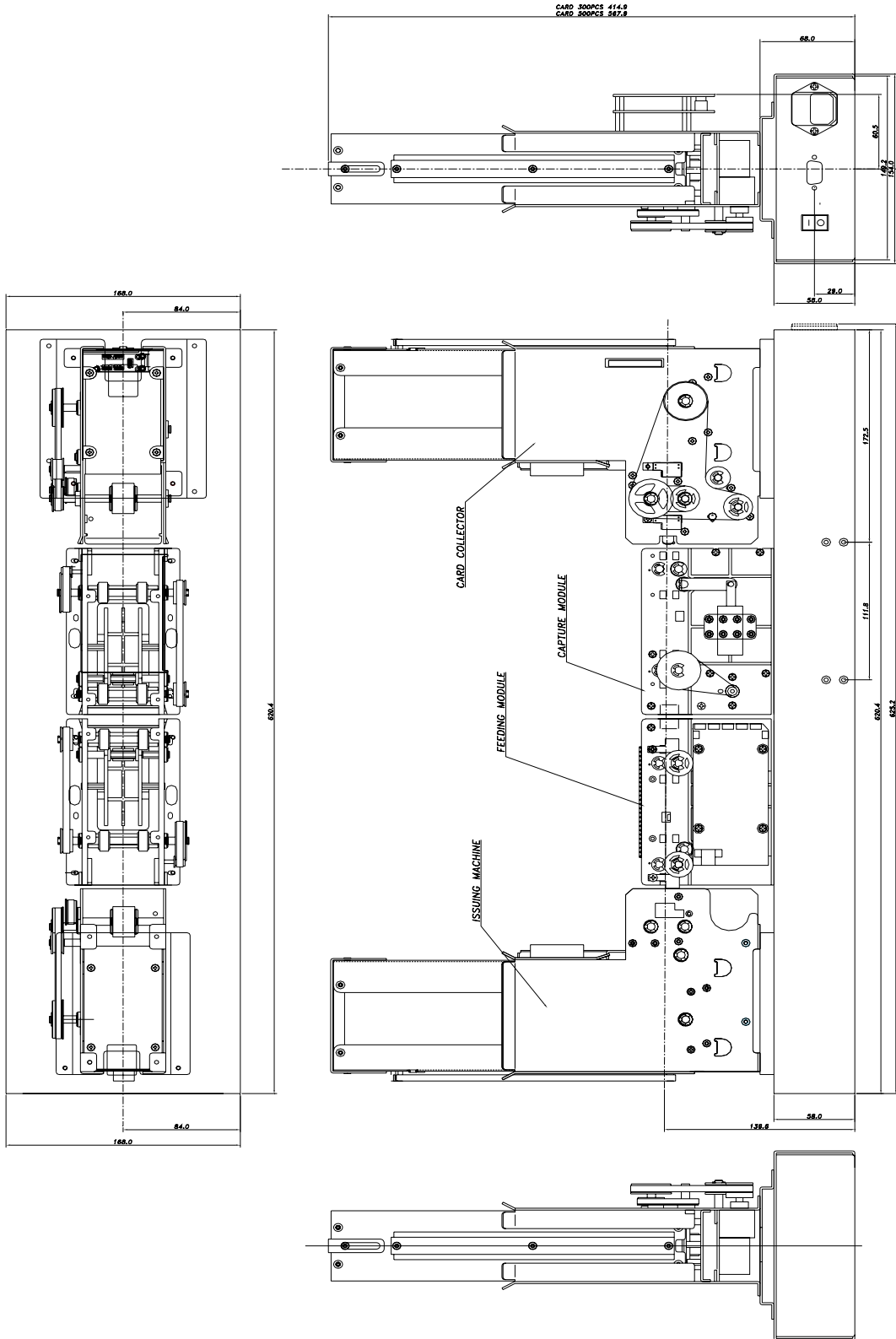

Doc No	CIS-2XXX SPECIFICATION	REV	PAGE	DATE
91000060		B	21 OF 57	2007. 10. 01.

COMMAND DETAIL

◆ *Command List*

	Item	Cm0	Cm1	Cm2	Detail	Note
COMMON	STATUS1	'C'	'1'	'1'	Get Model	
		'C'	'1'	'2'	Get Firmware Version	
		'C'	'1'	'3'	Get Cartridge	
		'C'	'1'	'6'	Get Card position	
	SETTING	'C'	'2'	'1'	Set RTC IC	Check*
		'C'	'2'	'4'	Set Retry Count	Check*
		'C'	'4'	'0'	Set User Buzz	
		C	'4'	'2'	Software Reset	
	MOVE	'C'	'3'	'1'	Card Move From Cartridge	
		'C'	'3'	'2'	Card Move To	
		'C'	'3'	'4'	Card Capture	
		'C'	'3'	'9'	Card Move Collector	
MAGNETIC CARD	MAGNETIC READ / WRITE	'M'	'3'	'1'	Magnetic Card Read	
		'M'	'3'	'3'	Magnetic Card Write	Verify**
		'M'	'3'	'4'	Magnetic Card Write From Catridge	Verify**
	CLEANING	'M'	'3'	'5'	Magnetic Card All Track Read	
IC CARD	IC CONTROL	'I'	'2'	'1'	IC Card Reset	
		'I'	'2'	'2'	IC Card Direct Control	
RF CARD	RF CARD READ / WRITE	'R'	'3'	'1'	RF Card Read in Block Range	
		'R'	'3'	'2'	RF Card Write in Block Range	Verify**
		'R'	'3'	'6'	RF Card Read in Sector Range	
		'R'	'3'	'7'	RF Card Write in Sector Range	
	BALANCE	'R'	'4'	'1'	Balance Increment	
		'R'	'4'	'2'	Balance Decrement	
	SECRET KEY CHANGE	'R'	'5'	'1'	Change 'Secret Key' to other Key	
		'R'	'5'	'2'	Change 'Secret Key' to all the same Key value	
		'R'	'5'	'3'	Select 'Secret Key Index'	
		'R'	'5'	'4'	Change 'RF Card Secret Key' to other Key	
		'R'	'5'	'5'	Key Set and Change 'Secret Key' to other Key	
		'R'	'5'	'6'	Key Set and Change 'Secret Key' to all the same Key value	
	RF DETECT	'R'	'6'	'1'	Check RF card in antenna area	

* Command Check possible with setting the terminal.

** After command execution, verify execution automatically.

Doc No	CIS-2XXX SPECIFICATION	REV	PAGE	DATE
91000060		B	22 OF 57	2007. 10. 01.

◆ *Common*

1 STATUS / SETTING

1.1 “C11” : It is to check out Model number of CIS-2000.

☞ Command Format

SOH	Null	Length	STX	“C11”	ETX	Bcc
-----	------	--------	-----	-------	-----	-----

☞ Positive Response Format

SOH	Null	Length	STX	“C11”	GOOD	0x01	DATA	ETX	Bcc
-----	------	--------	-----	-------	------	------	------	-----	-----

☞ Negative Response Format

SOH	Null	Length	STX	“C11”	E-Code	0x00	ETX	Bcc
-----	------	--------	-----	-------	--------	------	-----	-----

☞ Response Data Structure

Model No
30Byte (ASCII)

1.2 “C12” : It is to check out Firmware Version of CIS-2000

☞ Command Format

SOH	Null	Length	STX	“C12”	ETX	Bcc
-----	------	--------	-----	-------	-----	-----

☞ Positive Response Format

SOH	Null	Length	STX	“C12”	GOOD	0x01	DATA	ETX	Bcc
-----	------	--------	-----	-------	------	------	------	-----	-----

☞ Negative Response Format

SOH	Null	Length	STX	“C12”	E-Code	0x00	ETX	Bcc
-----	------	--------	-----	-------	--------	------	-----	-----

☞ Response Data Structure

Firmware Version
30Byte (ASCII)

Doc No	CIS-2XXX SPECIFICATION	REV	PAGE	DATE
91000060		B	23 OF 57	2007. 10. 01.

1.3 “C13” : It is check out status of Cartridge of CIS-2000

☞ Command Format

SOH	Null	Length	STX	“C13”	ETX	Bcc
-----	------	--------	-----	-------	-----	-----

☞ Positive Response Format

SOH	Null	Length	STX	“C13”	GOOD	0x01	DATA	ETX	Bcc
-----	------	--------	-----	-------	------	------	------	-----	-----

☞ Negative Response Format

SOH	Null	Length	STX	“C13”	E-Code	0x00	ETX	Bcc
-----	------	--------	-----	-------	--------	------	-----	-----

☞ Response Data Structure

Cartridge	0x00
1Byte (Hex)	1Byte (Hex)

☞ Data Variable

<Cartridge>

Code	Status	Note
0x01	Cartridge Empty(Dispenser)	
0x02	Cartridge Warning(Dispenser)	
0x04	No Cartridge (Dispenser)	
0x08	Cartridge Full (Collector)	
0x10	No Cartridge (Collector)	

☞ Note

Cartridge Status	Detail
Cartridge Empty(issuing)	No cards in stacker
Cartridge Warning(issuing)	A few card
Cartridge Good (Dispenser)	There is Cartridge
No Cartridge (Collector)	There is not Cartridge
Cartridge Full (Collector)	Too many cards loading

Doc No	CIS-2XXX SPECIFICATION	REV	PAGE	DATE
91000060		B	24 OF 57	2007. 10. 01.

1.4 “C16” : The card is checked by existent location.

☞ Command Format

SOH	Null	Length	STX	“C16”	ETX	Bcc
-----	------	--------	-----	-------	-----	-----

☞ Positive Response Format

SOH	Null	Length	STX	“C16”	GOOD	0x01	DATA	ETX	Bcc
-----	------	--------	-----	-------	------	------	------	-----	-----

☞ Negative Response Format

SOH	Null	Length	STX	“C16”	E-Code	0x00	ETX	Bcc
-----	------	--------	-----	-------	--------	------	-----	-----

☞ Response Data Structure

Card Position
1Byte (Hex)

☞ Data Variable

<Card Position>

Code	Sensor	Detail
0x01	SENSOR1	The card is locate NO.1
0x02	SENSOR 2	The card is locate NO.2
0x04	SENSOR 3	The card is locate NO.3
0x08	SENSOR 4	The card is locate NO.4
0x10	SENSOR 5	The card is locate NO.5
0x20	SENSOR 6	The card is locate NO.6
0x40	SENSOR 7	The card is locate NO.7
0x80	SENSOR 8	The card is locate NO.8

Doc No	CIS-2XXX SPECIFICATION	REV	PAGE	DATE
91000060		B	25 OF 57	2007. 10. 01.

<CARD POSITION>

<CIS-21XX, CIS-22XX, CIS-23XX, CIS-24XX, CIS-25XX, CIS-27XX >

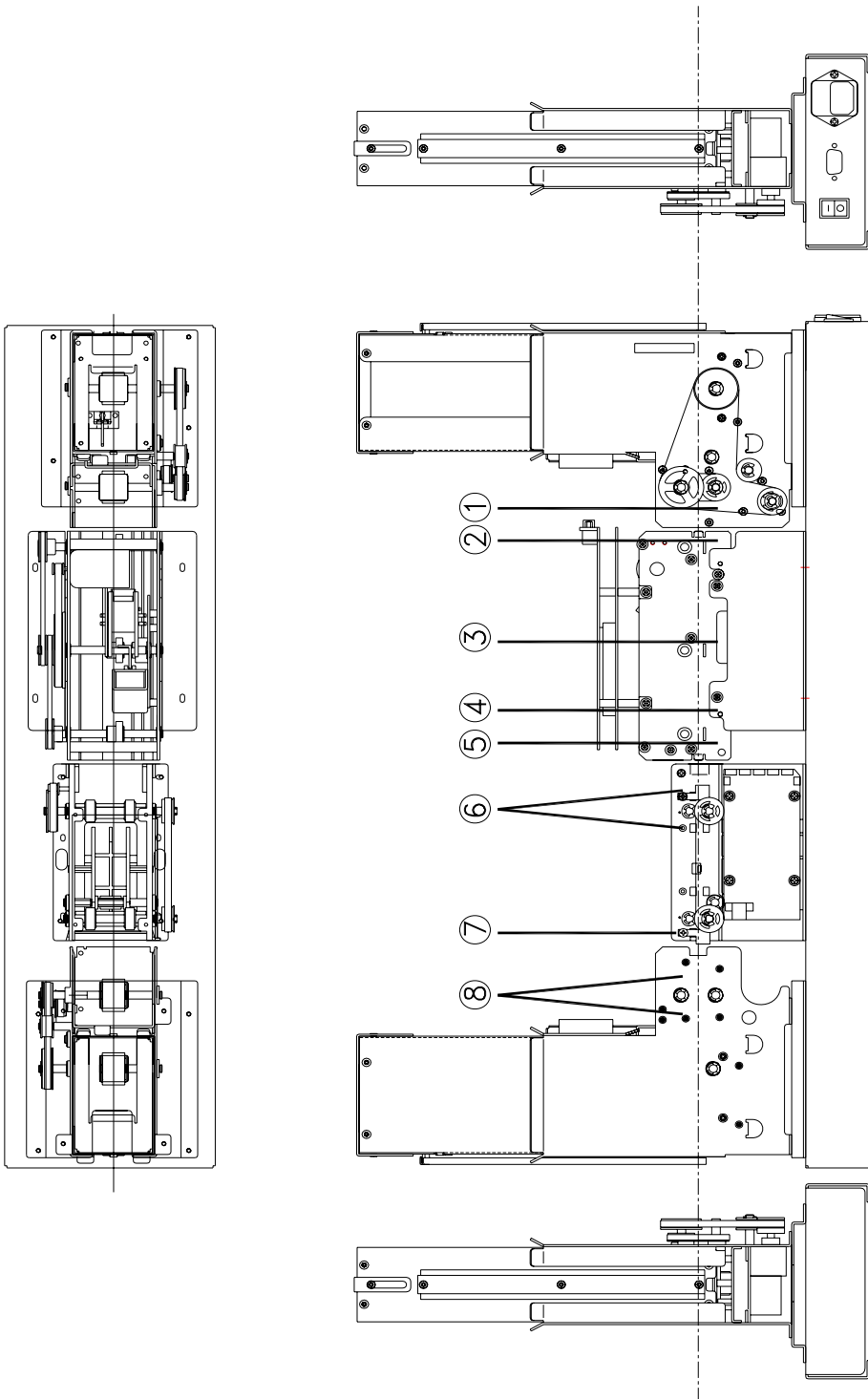

Doc No	CIS-2XXX SPECIFICATION	REV	PAGE	DATE
91000060		B	26 OF 57	2007. 10. 01.

<CIS-26XX>

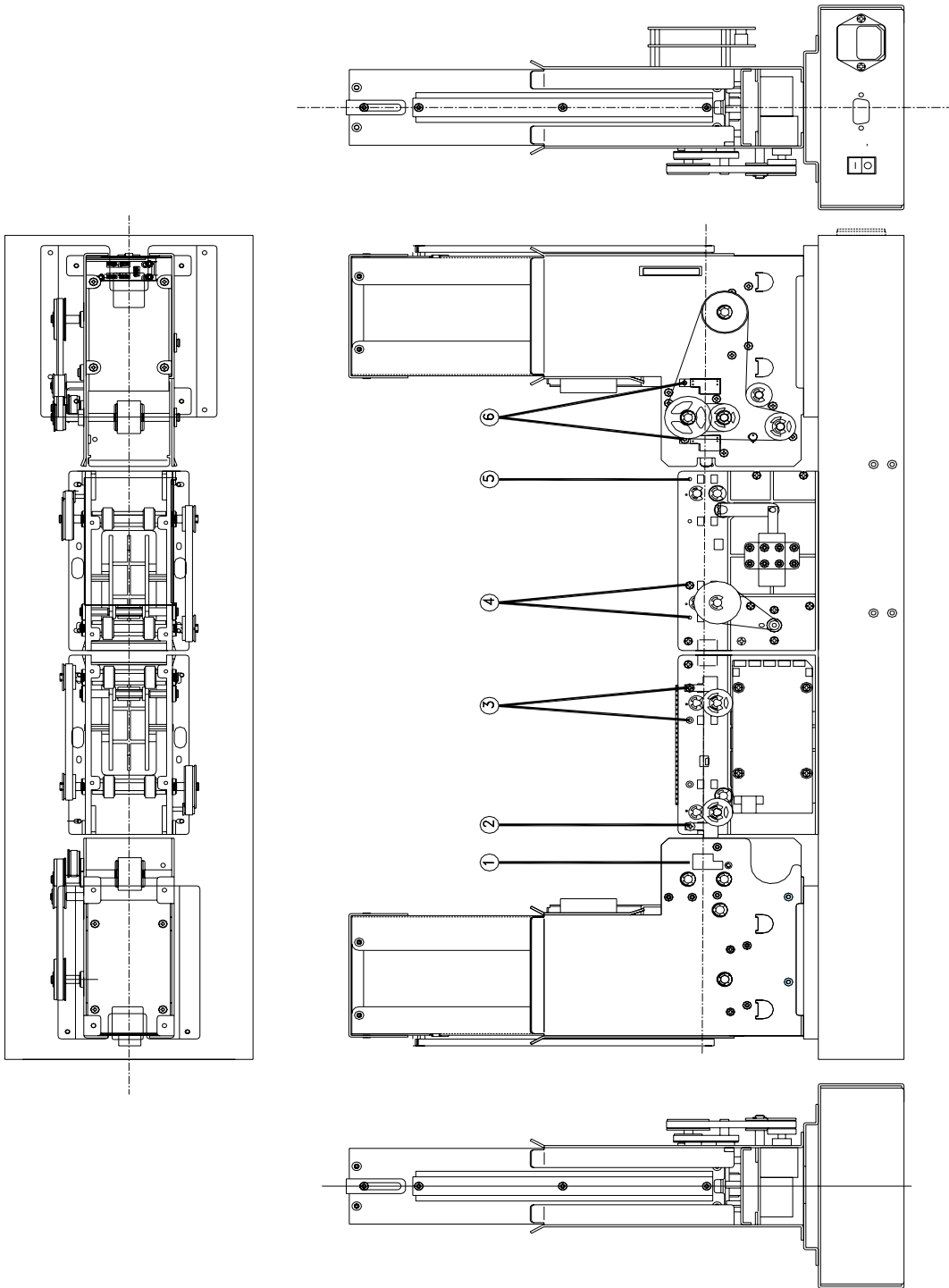

Doc No	CIS-2XXX SPECIFICATION	REV	PAGE	DATE
91000060		B	27 OF 57	2007. 10. 01.

2 SETTING

2.1 “C21” : It is to set or to check ‘RTC IC’.

☞ Command Format

SOH	Null	Length	STX	“C21”	DATA	ETX	Bcc
-----	------	--------	-----	-------	------	-----	-----

☞ Command Data Structure

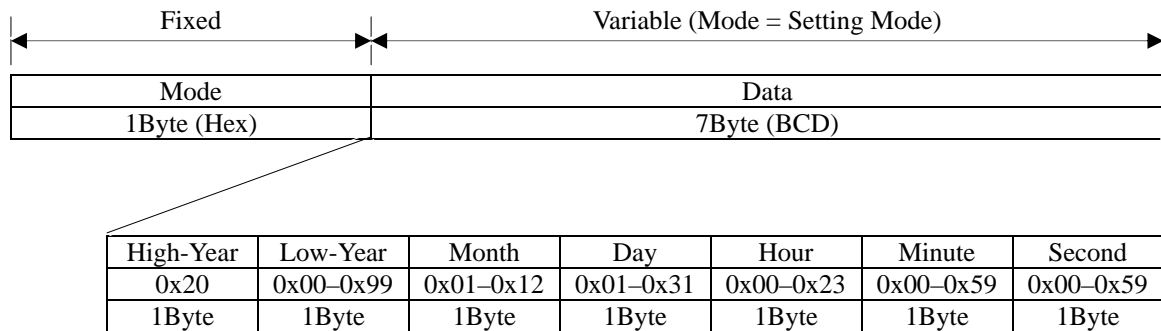

☞ Positive Response Format

SOH	Null	Length	STX	“C21”	GOOD	0x01	DATA	ETX	Bcc
-----	------	--------	-----	-------	------	------	------	-----	-----

☞ Negative Response Format

SOH	Null	Length	STX	“C21”	E-Code	0x00	ETX	Bcc
-----	------	--------	-----	-------	--------	------	-----	-----

☞ Response Data Structure

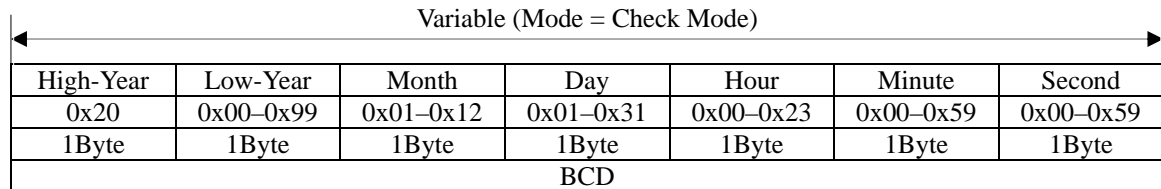

☞ Data Variable

<Mode>

Code	Mode	Detail
0x01	‘Setting Mode’	Set ‘RTC IC’
0x02	‘Check Mode’	Check ‘RTC IC’

☞ Note

‘Day’ is changeable due to the value of ‘Month’.

Doc No	CIS-2XXX SPECIFICATION	REV	PAGE	DATE
91000060		B	28 OF 57	2007. 10. 01.

2.2 “C24” : It is to set or to check ‘Retry Count’.

☞ Command Format

SOH	Null	Length	STX	“C24”	DATA	ETX	Bcc
-----	------	--------	-----	-------	------	-----	-----

☞ Command Data Structure

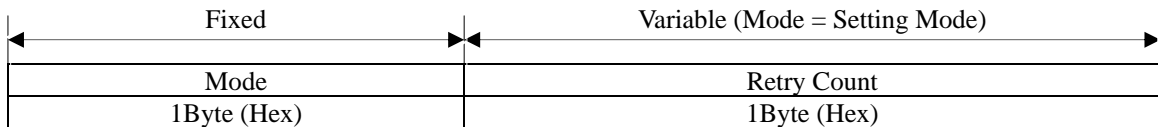

☞ Positive Response Format

SOH	Null	Length	STX	“C24”	GOOD	0x01	DATA	ETX	Bcc
-----	------	--------	-----	-------	------	------	------	-----	-----

☞ Negative Response Format

SOH	Null	Length	STX	“C24”	E-Code	0x00	ETX	Bcc
-----	------	--------	-----	-------	--------	------	-----	-----

☞ Response Data Structure

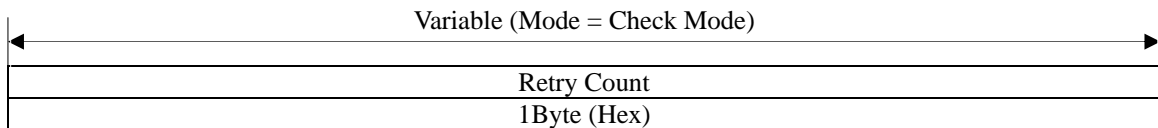

☞ Data Variable

<Mode>

Code	Mode	Detail
0x01	‘Setting Mode’	Set ‘Retry Count’
0x02	‘Check Mode’	Check ‘Retry Count’

<Retry Count>

Code	Setting	Detail	Note
0x00	NON	Do not retry	
0x01	Once	Execute the instruction again.	
0x02	Twice	Retry it twice	
0x03	Three times	Retry it three times	Default

Doc No	CIS-2XXX SPECIFICATION	REV	PAGE	DATE
91000060		B	29 OF 57	2007. 10. 01.

2.3 “C40” : The BUZZ is operate by internal terminal.

☞ Command Format

SOH	Null	Length	STX	“C40”	DATA	ETX	Bcc
-----	------	--------	-----	-------	------	-----	-----

☞ Command Data Structure

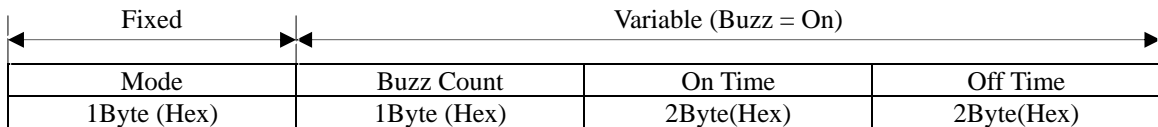

☞ Positive Response Format

SOH	Null	Length	STX	“C40”	GOOD	0x01	ETX	Bcc
-----	------	--------	-----	-------	------	------	-----	-----

☞ Negative Response Format

SOH	Null	Length	STX	“C40”	E-Code	0x00	ETX	Bcc
-----	------	--------	-----	-------	--------	------	-----	-----

☞ Data Variable

<Mode>

Code	Buzz	Detail
0x01	On	Set Buzz ON
0x02	Off	Set Buzz OFF

<Buzz Count>

Code	Buzz Count	Detail	Note
0x00	Continuous	Buzz continuous occur.	Default
0x01	1	Buzz one time occur.	Note
0x02	2	Buzz two times occur.	Note
---	---	---	---
0x64	100	Buzz hundred times occur.	Note

<On Time/Off Time>

Code	Range	Detail	Note
On Time	100 – 10000	Buzz sound active time	mSec
Off Time	100 – 10000	Buzz sound nonactive time.	mSec

<On Time>, <Off Time>

High Byte	Low Byte
-----------	----------

☞ Note

If set ‘Buzz one time occur’, after the terminal is Buzz one time occur, return to ‘Buzz Off’ state.

Doc No	CIS-2XXX SPECIFICATION	REV	PAGE	DATE
91000060		B	30 OF 57	2007. 10. 01.

2.4 “C42” : Software RESET for Main Board

☞ Command Format

SOH	Null	Length	STX	“C42”	ETX	Bcc
-----	------	--------	-----	-------	-----	-----

☞ Positive Response Format

SOH	Null	Length	STX	“C42”	GOOD	0x01	ETX	Bcc
-----	------	--------	-----	-------	------	------	-----	-----

☞ Negative Response Format

SOH	Null	Length	STX	“C42”	E-Code	0x00	ETX	Bcc
-----	------	--------	-----	-------	--------	------	-----	-----

☞ Note

This “C42” Software RESET command is effective for CIS-2000 MAIN BOARD only.

Card Dispenser and Card Reader do not Reset

With this software RESET, all the data in the CIS-2000 return to DEFAULT value.

After “RESET”, minimum 3 seconds is required before running to get secure operation.

Doc No	CIS-2XXX SPECIFICATION	REV	PAGE	DATE
91000060		B	31 OF 57	2007. 10. 01.

3 MOVE

3.1 “C31” : It is to take a card from Cartridge and to move it to Card Reader / Writer Module.

☞ Command Format

SOH	Null	Length	STX	“C31”	DATA	ETX	Bcc
-----	------	--------	-----	-------	------	-----	-----

☞ Command Data Structure

0x00	Module
1Byte (Hex)	1Byte (Hex)

☞ Positive Response Format

SOH	Null	Length	STX	“C31”	GOOD	0x01	ETX	Bcc
-----	------	--------	-----	-------	------	------	-----	-----

☞ Negative Response Format

SOH	Null	Length	STX	“C31”	E-Code	0x00	ETX	Bcc
-----	------	--------	-----	-------	--------	------	-----	-----

☞ Data Variable

<Module>

Code	Setting	Detail
0x01	MSRW	Card transport to MSRW Module
0x02	IC	Card transport to IC Module
0x03	RF	Card transport to RF Module
0x04	FEEDER	Card transport to FEEDER Module

3.2 “C32” : It is take card to Card Reader / Writer Module

☞ Command Format

SOH	Null	Length	STX	“C32”	DATA	ETX	Bcc
-----	------	--------	-----	-------	------	-----	-----

☞ Command Data Structure

Module
1Byte (Hex)

☞ Positive Response Format

SOH	Null	Length	STX	“C32”	GOOD	0x01	DATA	ETX	Bcc
-----	------	--------	-----	-------	------	------	------	-----	-----

☞ Negative Response Format

SOH	Null	Length	STX	“C32”	E-Code	0x00	ETX	Bcc
-----	------	--------	-----	-------	--------	------	-----	-----

☞ Data Variable

<Module>

Code	Setting	Detail
0x01	MSRW	Card transport to MSRW Module
0x02	IC	Card transport to IC Module
0x03	RF	Card transport to RF Module
0x04	FEEDER	Card transport to FEEDER Module

Doc No	CIS-2XXX SPECIFICATION	REV	PAGE	DATE
91000060		B	32 OF 57	2007. 10. 01.

3.3 “C34” : It takes card to Bin Box (Capture)

☞ Command Format

SOH	Null	Length	STX	“C34”	ETX	Bcc
-----	------	--------	-----	-------	-----	-----

☞ Positive Response Format

SOH	Null	Length	STX	“C34”	GOOD	0x01	ETX	Bcc
-----	------	--------	-----	-------	------	------	-----	-----

☞ Negative Response Format

SOH	Null	Length	STX	“C34”	E-Code	0x00	ETX	Bcc
-----	------	--------	-----	-------	--------	------	-----	-----

3.4 “C39” : It is to take a card from Cartridge and to move it to Card Reader / Writer Module.

☞ Command Format

SOH	Null	Length	STX	“C39”	DATA	ETX	Bcc
-----	------	--------	-----	-------	------	-----	-----

☞ Command Data Structure

Cartridge
1Byte (Hex : 0x01)

☞ Positive Response Format

SOH	Null	Length	STX	“C39”	GOOD	0x01	ETX	Bcc
-----	------	--------	-----	-------	------	------	-----	-----

☞ Negative Response Format

SOH	Null	Length	STX	“C39”	E-Code	0x00	ETX	Bcc
-----	------	--------	-----	-------	--------	------	-----	-----

Doc No	CIS-2XXX SPECIFICATION	REV	PAGE	DATE
91000060		B	33 OF 57	2007. 10. 01.

◆ *MAGNETIC CARD*

This section describes the commands that can use at the magnetic card.

The data to be written in every track should be conform to the ISO7816-2 standard, the available character is as follows. For more information about Magnetic card, refer to the ISO7816-2 standard.

Track	Available Character Set	Maximum characters	Note
Track #1	Character, Numbers	76	Except for the special character
Track #2	Numbers	37	
Track #3	Numbers	104	

The CIS-2000 provides two features for speedy processing. The first is to provide the command combined with 'FromStacker' and 'Magnetic Write' command. This feature enables to write on card in the dispenser stacker at a command.

The second is to lessen the processing time for the 'magnetic read' command repeated after latching the data read from card. To latch data occurs at a point of time when verify in the magnetic write command and execute the magnetic read command. However, the latched data is erased when the card is off from the terminal.

Doc No	CIS-2XXX SPECIFICATION	REV	PAGE	DATE
91000060		B	34 OF 57	2007. 10. 01.

Basic Magnetic Card Operations:

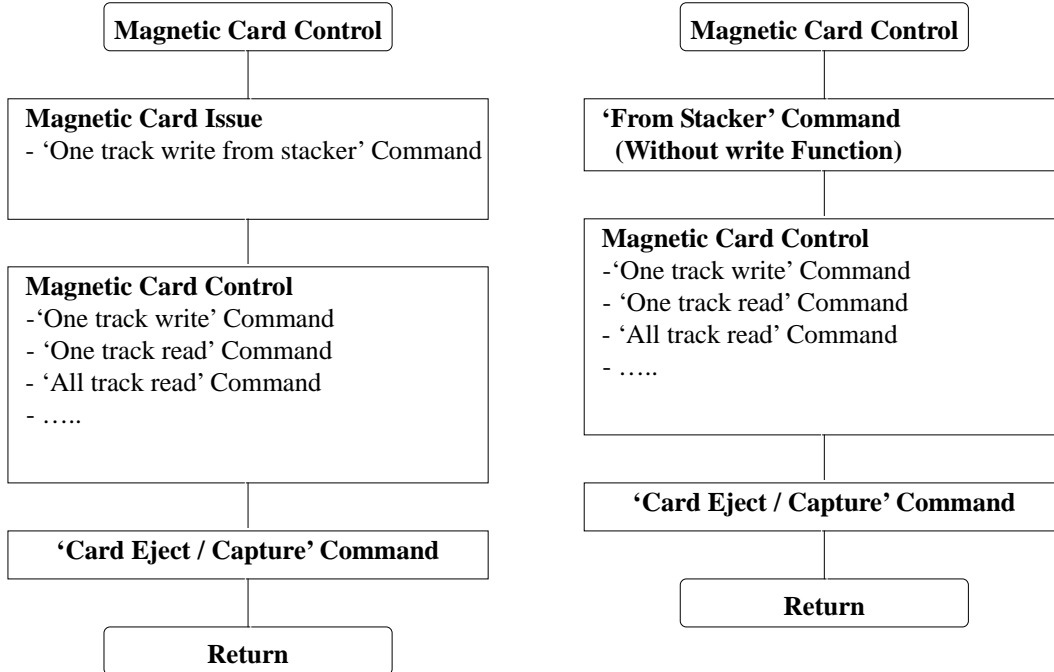

Magnetic Card Operations in the stacker

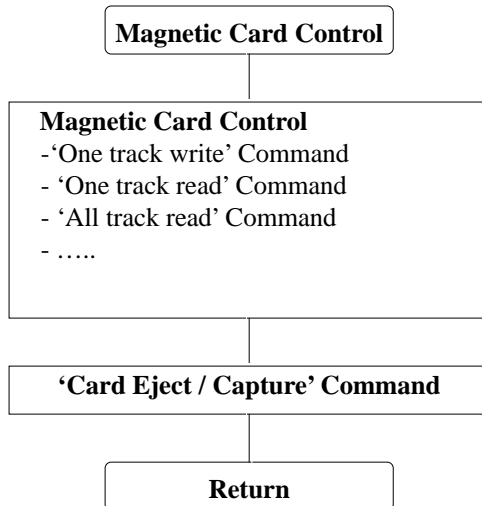

Magnetic Card Operations in the terminal

Doc No	CIS-2XXX SPECIFICATION	REV	PAGE	DATE
91000060		B	35 OF 57	2007. 10. 01.

1 MAGNETIC READ / WRITE

1.1 “M31” : It is to read data on track chosen.

☞ Command Format

SOH	Null	Length	STX	“M31”	DATA	ETX	Bcc
-----	------	--------	-----	-------	------	-----	-----

☞ Command Data Structure

Track (1Byte)

☞ Positive Response Format

SOH	Null	Length	STX	“M31”	GOOD	0x01	DATA	ETX	Bcc
-----	------	--------	-----	-------	------	------	------	-----	-----

☞ Negative Response Format

SOH	Null	Length	STX	“M31”	E-Code	0x00	ETX	Bcc
-----	------	--------	-----	-------	--------	------	-----	-----

☞ Response Data Structure

Read Data (ASCII Code)

☞ Data Variable

<Track>

Code	Setting	Detail
0x01	Track 1	Read data on Track 1
0x02	Track 2	Read data on Track 2
0x03	Track 3	Read data on Track 3

☞ Note

If the ‘Magnetic Read’ command is executed normally, the read data is latched.

1.2 “M33” : It is to write data on track chosen.

☞ Command Format

SOH	Null	Length	STX	“M33”	DATA	ETX	Bcc
-----	------	--------	-----	-------	------	-----	-----

☞ Command Data Structure

Track	Write Data
1Byte (Hex)	(ASCII Code)

☞ Positive Response Format

SOH	Null	Length	STX	“M33”	GOOD	0x01	ETX	Bcc
-----	------	--------	-----	-------	------	------	-----	-----

☞ Negative Response Format

SOH	Null	Length	STX	“M33”	E-Code	0x00	ETX	Bcc
-----	------	--------	-----	-------	--------	------	-----	-----

☞ Data Variable

<Track>

Code	Setting	Detail
0x01	Track 1	Write data to Track 1
0x02	Track 2	Write data to Track 2
0x03	Track 3	Write data to Track 3

☞ Note

If the ‘Magnetic Write’ command is executed normally, the written data is latched. This command has the ‘Verify’ feature.

Doc No	CIS-2XXX SPECIFICATION	REV	PAGE	DATE
91000060		B	36 OF 57	2007. 10. 01.

1.3 “M34” : It is to take a card from Stacker and to write data to a selected track.

☞ Command Format

SOH	Null	Length	STX	“M34”	DATA	ETX	Bcc
-----	------	--------	-----	-------	------	-----	-----

☞ Command Data Structure

0x00	Track	Write Data
1Byte (Hex)	1Byte (Hex)	(ASCII Code)

☞ Positive Response Format

SOH	Null	Length	STX	“M34”	GOOD	0x01	ETX	Bcc
-----	------	--------	-----	-------	------	------	-----	-----

☞ Negative Response Format

SOH	Null	Length	STX	“M34”	E-Code	0x00	ETX	Bcc
-----	------	--------	-----	-------	--------	------	-----	-----

☞ Data Variable

<Track>

Code	Setting	Detail
0x01	Track 1	Write data to Track 1
0x02	Track 2	Write data to Track 2
0x03	Track 3	Write data to Track 3

☞ Note

This command has the Data ‘Latch ‘and ‘Verify’ features.

1.4 “M35” : It is to read data from all three tracks.

☞ Command Format

SOH	Null	Length	STX	“M35”	ETX	Bcc
-----	------	--------	-----	-------	-----	-----

☞ Positive Response Format

SOH	Null	Length	STX	“M35”	GOOD	0x01	DATA	ETX	Bcc
-----	------	--------	-----	-------	------	------	------	-----	-----

☞ Negative Response Format

SOH	Null	Length	STX	“M35”	E-Code	0x00	ETX	Bcc
-----	------	--------	-----	-------	--------	------	-----	-----

☞ Response Data Structure

0x00	Track1 Data	0x00	Track2 Data	0x00	Track3 Data
1Byte(Hex)	(ASCII)	1Byte(Hex)	(ASCII)	1Byte(Hex)	(ASCII)

☞ Note

If the ‘Magnetic Read’ command is executed normally, the read data is latched.

Doc No	CIS-2XXX SPECIFICATION	REV	PAGE	DATE
91000060		B	37 OF 57	2007. 10. 01.

2 CLEANING

2.1 “M51” : It is to clean Magnetic Head mounted inside MSRW.

☞ Command Format

SOH	Null	Length	STX	“M51”	ETX	Bcc
-----	------	--------	-----	-------	-----	-----

☞ Positive Response Format

SOH	Null	Length	STX	“M51”	GOOD	0x01	ETX	Bcc
-----	------	--------	-----	-------	------	------	-----	-----

☞ Negative Response Format

SOH	Null	Length	STX	“M51”	E-Code	0x00	ETX	Bcc
-----	------	--------	-----	-------	--------	------	-----	-----

Doc No	CIS-2XXX SPECIFICATION	REV	PAGE	DATE
91000060		B	38 OF 57	2007. 10. 01.

◆ *IC CARD*

This section describes the commands that can use at the IC card

The IC card should conform to the ISO7816-4 T=0/T=1, these cards is available.

Basic Operating Procedure for the IC card and Memory Card:

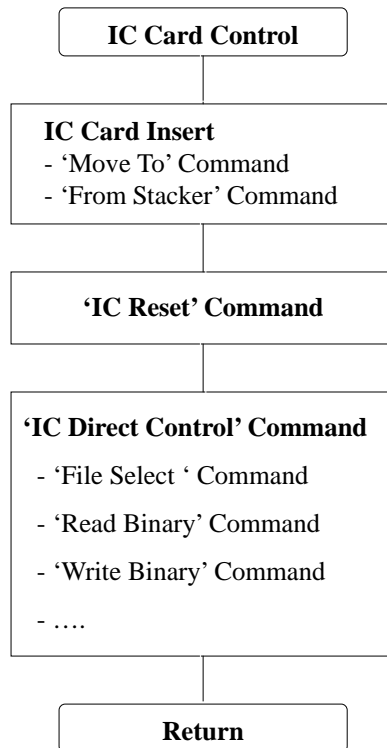

Doc No	CIS-2XXX SPECIFICATION	REV	PAGE	DATE
91000060		B	39 OF 57	2007. 10. 01.

1 IC CONTROL

1.1 “I21” : Reset the IC card and receive the ATR from card.

Command Format

SOH	Null	Length	STX	“I21”	ETX	Bcc
-----	------	--------	-----	-------	-----	-----

Positive Response Format

SOH	Null	Length	STX	“I21”	GOOD	0x01	DATA	ETX	Bcc
-----	------	--------	-----	-------	------	------	------	-----	-----

Negative Response Format

SOH	Null	Length	STX	“I21”	E-Code	0x00	ETX	Bcc
-----	------	--------	-----	-------	--------	------	-----	-----

Response Data Structure

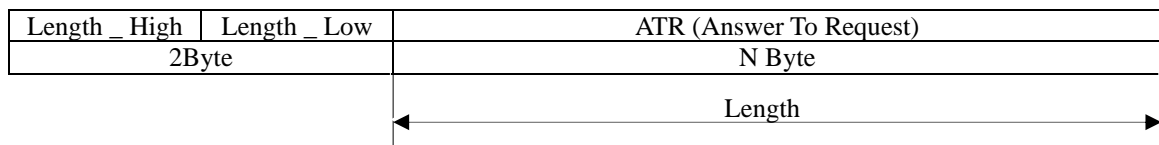

Example

SAMSUNG SCOS ATR

15 Byte	0x3B	0x6B	0x00	0x00	0x80	0x31	0x80	0x63
	0x53	0x46	0x01	0x83	0x03	0x90	0x00	

1.2 “I22” : Control the card conforming to the ISO 7816 T=0 / T=1, ISO 7816 – 4 standard directly.

Command Format

SOH	Null	Length	STX	“I22”	DATA	ETX	Bcc
-----	------	--------	-----	-------	------	-----	-----

Command Data Structure

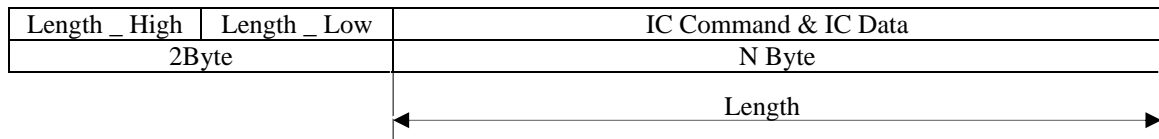

Positive Response Format

SOH	Null	Length	STX	“I22”	GOOD	0x01	DATA	ETX	Bcc
-----	------	--------	-----	-------	------	------	------	-----	-----

Negative Response Format

SOH	Null	Length	STX	“I22”	E-Code	0x00	ETX	Bcc
-----	------	--------	-----	-------	--------	------	-----	-----

Response Data Structure

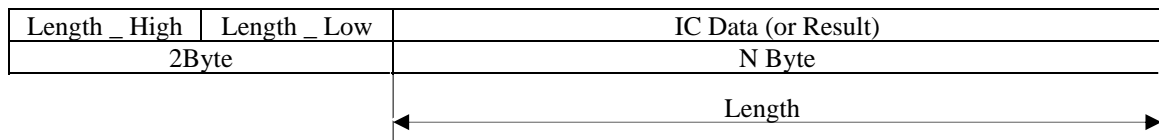

Doc No	CIS-2XXX SPECIFICATION	REV	PAGE	DATE
91000060		B	40 OF 57	2007. 10. 01.

IC Command & IC Data Structure

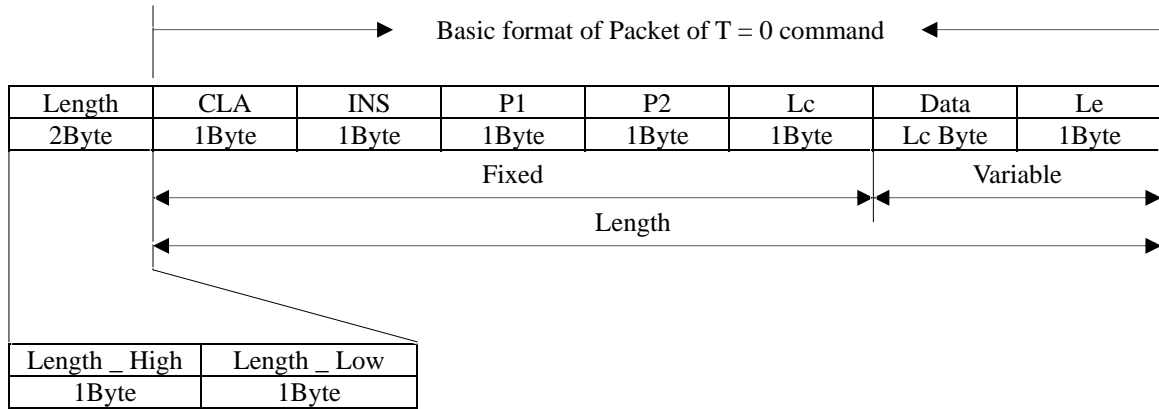

CLA	Class	Note
INS	Instruction	
P1	Offset(High Value)	
P2	Offset(Low Value)	
Lc	A number of data to transfer	Max Value : 255
Data	Data to Transfer	
Le	A number of data to receive	

Format of T = 0 Command

Command	INS Code (Hex Value)
Read Binary Command	B0
Write Binary Command	D0
Update Binary Command	D6
Erase Binary Command	0E
Read Record(s) Command	B2
Write Record Command	D2
Append Record Command	E2
Update Record Command	DC
Get Data Command	CA
Put Data Command	DA
Select File Command	A4
Verify Command	20
Internal Authenticate Command	88
External Authenticate Command	82
Get Challenge Command	84
Manage Channel Command	70

For more information, refer to the ISO 7816 – 4 standard.

Doc No	CIS-2XXX SPECIFICATION	REV	PAGE	DATE
91000060		B	41 OF 57	2007. 10. 01.

☞ Frame Command for SAMSUNG SCOS 3.0

Command	INS Code (Hex Value)
Put Key	EA
Create File	E0
Block	1E
UnBlock	18
Create Session	8A
Set Life Cycle	E8
Forbidden AC	1C
Initialize IEP	50
Load / Cancel IEP	52
Purchase /Unload / Complete IEP	54
Update Parameter	56
Read Balance	5C

Doc No	CIS-2XXX SPECIFICATION	REV	PAGE	DATE
91000060		B	42 OF 57	2007. 10. 01.

◆ *RF CARD*

This section describes the commands that can use at the 'RF CARD'.

The RF Module of his model supports only the MIFARE card.

The applicable models of the CIS-2000 Series are the CIS-2400, CIS-2600, CIS-2700, the available commands are as follows.

Item	Cm0	Cm1	Cm2	Detail	Note
RF CARD READ / WRITE	'R'	'3'	'1'	RF Card Read in Block Range	
	'R'	'3'	'2'	RF Card Write in Block Range	Verify
	'R'	'3'	'6'	RF Card Read in Sector Range	
	'R'	'3'	'7'	RF Card Write in Sector Range	
BALANCE	'R'	'4'	'1'	Balance Increment	
	'R'	'4'	'2'	Balance Decrement	
SECRET KEY CHANGE	'R'	'5'	'1'	Change 'Secret Key' to other Key	
	'R'	'5'	'2'	Change 'Secret Key' to all the same Key value	
	'R'	'5'	'3'	Select 'Secret Key Index'	
	'R'	'5'	'4'	Change 'RF Card Secret Key' to other Key	
	'R'	'5'	'5'	Key Set and Change 'Secret Key' to other Key	
	'R'	'5'	'6'	Key Set and Change 'Secret Key' to all the same Key value	
RF DETECT	'R'	'6'	'1'	Check RF card in antenna area	

To use the RF card, you need to initialize at first.

- Setting and updating of the secret key and secret key index.

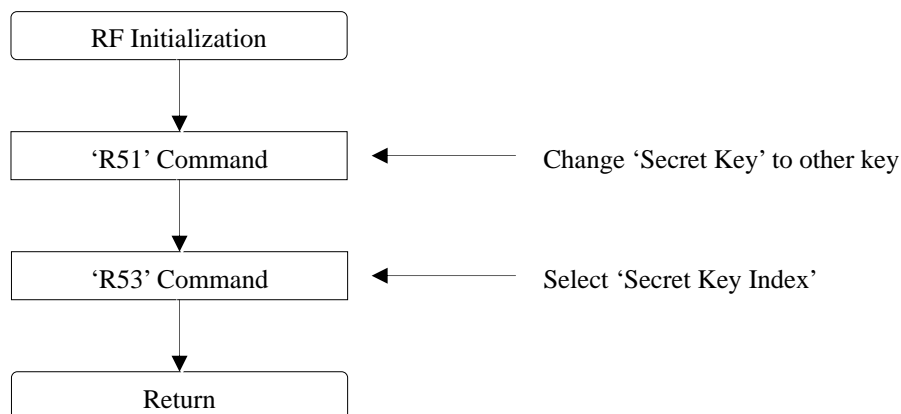

RF Module Initialization

Doc No	CIS-2XXX SPECIFICATION	REV	PAGE	DATE
91000060		B	43 OF 57	2007. 10. 01.

Basic Operating Procedure of the RF card:

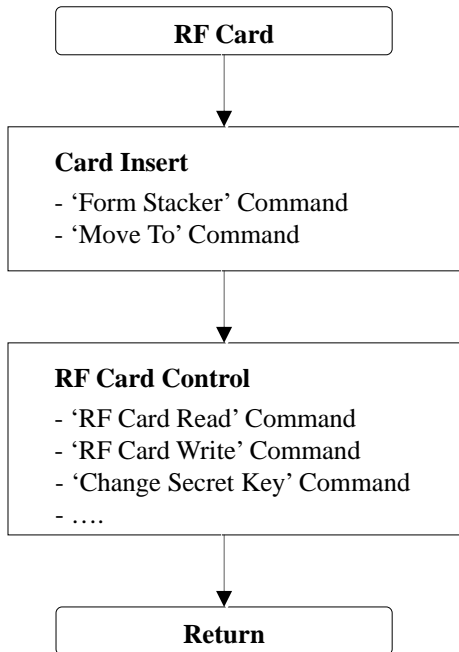

RF Card Basic Operating Procedures

Memory Architecture(map) of the RF card: 8Kbit

Sector	Block	Size	Detail	Note
Sector 0	Block 0	16Byte	RF Card Information	Can't use
	Block 1	16Byte		
	Block 2	16Byte	'Sector Key'	
	Block 3	16Byte		
Sector 1	Block 0	16Byte	User Available Memory	
	Block 1	16Byte		
	Block 2	16Byte	'Sector Key'	
	Block 3	16Byte		
Sector 2	Block 0	16Byte	User Available Memory	
	Block 1	16Byte		
	Block 2	16Byte	'Sector Key'	
	Block 3	16Byte		
---	---	---	---	---
Sector 15	Block 0	16Byte	User Available Memory	
	Block 1	16Byte		
	Block 2	16Byte	'Sector Key'	
	Block 3	16Byte		

Doc No	CIS-2XXX SPECIFICATION	REV	PAGE	DATE
91000060		B	44 OF 57	2007. 10. 01.

1 RF CARD READ / WRITE

1.1 "R31" : Read RF card data & Secret Key in block range

☞ Command Format

SOH	Null	Length	STX	"R31"	DATA	ETX	Bcc
-----	------	--------	-----	-------	------	-----	-----

☞ Command Data Structure

Sector	Block
0x00 – 0x0f	0x00 – 0x03
1Byte (Hex)	1Byte (Hex)

☞ Positive Response Format

SOH	Null	Length	STX	"R31"	GOOD	0x01	DATA	ETX	Bcc
-----	------	--------	-----	-------	------	------	------	-----	-----

☞ Negative Response Format

SOH	Null	Length	STX	"R31"	E-Code	0x00	ETX	Bcc
-----	------	--------	-----	-------	--------	------	-----	-----

☞ Response Data Structure

Sector	Block	Read Data
1Byte (Hex)	1Byte (Hex)	16 Byte (Hex)

D0	D1	D2	---	D14	D15
1Byte	1Byte	1Byte	---	1Byte	1Byte

1.2 "R32" : Write RF card data in block range

☞ Command Format

SOH	Null	Length	STX	"R32"	DATA	ETX	Bcc
-----	------	--------	-----	-------	------	-----	-----

☞ Command Data Structure

Sector	Block	Write Data
0x00 – 0x0f	0x00 – 0x02	0x00 – 0xff
1Byte (Hex)	1Byte (Hex)	16Byte (Hex)

D0	D1	D2	---	D14	D15
1Byte	1Byte	1Byte	---	1Byte	1Byte

☞ Positive Response Format

SOH	Null	Length	STX	"R32"	GOOD	0x01	ETX	Bcc
-----	------	--------	-----	-------	------	------	-----	-----

☞ Negative Response Format

SOH	Null	Length	STX	"R32"	E-Code	0x00	ETX	Bcc
-----	------	--------	-----	-------	--------	------	-----	-----

Doc No	CIS-2XXX SPECIFICATION	REV	PAGE	DATE
91000060		B	45 OF 57	2007. 10. 01.

1.3 “R36” : Read RF card data in sector range

☞ Command Format

SOH	Null	Length	STX	“R36”	DATA	ETX	Bcc
-----	------	--------	-----	-------	------	-----	-----

☞ Command Data Structure

Sector
0x00 – 0x0f
1Byte (Hex)

☞ Positive Response Format

SOH	Null	Length	STX	“R36”	GOOD	0x01	DATA	ETX	Bcc
-----	------	--------	-----	-------	------	------	------	-----	-----

☞ Negative Response Format

SOH	Null	Length	STX	“R36”	E-Code	0x00	ETX	Bcc
-----	------	--------	-----	-------	--------	------	-----	-----

☞ Response Data Structure

Sector	0x00	Read Data (0)	0x01	Read Data (1)	0x02	Read Data (2)
1Byte(Hex)	1Byte(Hex)	16Byte (Hex)	1Byte (Hex)	16Byte (Hex)	1Byte (Hex)	16Byte (Hex)

D0	D1	D2	---	D14	D15
1Byte	1Byte	1Byte	---	1Byte	1Byte

1.4 “R37” : Write RF card data in sector range (except Sector 0)

☞ Command Format

SOH	Null	Length	STX	“R37”	DATA	ETX	Bcc
-----	------	--------	-----	-------	------	-----	-----

☞ Command Data Structure

Sector	Write Data
0x01 – 0x0f	0x00 – 0xff
1Byte (Hex)	51Byte (Hex)

0x00	Read Data (0)	0x01	Read Data (1)	0x02	Read Data (2)
1Byte (Hex)	16Byte (Hex)	1Byte (Hex)	16Byte (Hex)	1Byte (Hex)	16Byte (Hex)

D0	D1	D2	---	D14	D15
1Byte	1Byte	1Byte	---	1Byte	1Byte

☞ Positive Response Format

SOH	Null	Length	STX	“R37”	GOOD	0x01	ETX	Bcc
-----	------	--------	-----	-------	------	------	-----	-----

☞ Negative Response Format

SOH	Null	Length	STX	“R37”	E-Code	0x00	ETX	Bcc
-----	------	--------	-----	-------	--------	------	-----	-----

Doc No	CIS-2XXX SPECIFICATION	REV	PAGE	DATE
91000060		B	46 OF 57	2007. 10. 01.

2 BALANCE

2.1 “R41” : Increment the balance of card to the specified amount.

☞ Command Format

SOH	Null	Length	STX	“R41”	DATA	ETX	Bcc
-----	------	--------	-----	-------	------	-----	-----

☞ Command Data Structure

Sector	Block	Index Value
0x00 – 0x0f	0x00 – 0x02	0x00000000 – 0xffffffff
1Byte (Hex)	1Byte (Hex)	4Byte (Hex)

V0	V1	V2	V3
0x00-0xff	0x00-0xff	0x00-0xff	0x00-0xff
1Byte(Hex, LSB)	1Byte(Hex)	1Byte(Hex)	1Byte(Hex, MSB)

☞ Positive Response Format

SOH	Null	Length	STX	“R41”	GOOD	0x01	ETX	Bcc
-----	------	--------	-----	-------	------	------	-----	-----

☞ Negative Response Format

SOH	Null	Length	STX	“R41”	E-Code	0x00	ETX	Bcc
-----	------	--------	-----	-------	--------	------	-----	-----

☞ Note

The balance should be written in the Electronic Purse format in the card.

2.1 “R42” : Decrement the balance of card to the specified amount..

☞ Command Format

SOH	Null	Length	STX	“R42”	DATA	ETX	Bcc
-----	------	--------	-----	-------	------	-----	-----

☞ Command Data Structure

Sector	Block	Index Value
0x00 – 0x0f	0x00 – 0x02	0x00000000 – 0xffffffff
1Byte (Hex)	1Byte (Hex)	4Byte (Hex)

V0	V1	V2	V3
0x00-0xff	0x00-0xff	0x00-0xff	0x00-0xff
1Byte(Hex, LSB)	1Byte(Hex)	1Byte(Hex)	1Byte(Hex, MSB)

☞ Positive Response Format

SOH	Null	Length	STX	“R42”	GOOD	0x01	ETX	Bcc
-----	------	--------	-----	-------	------	------	-----	-----

☞ Negative Response Format

SOH	Null	Length	STX	“R42”	E-Code	0x00	ETX	Bcc
-----	------	--------	-----	-------	--------	------	-----	-----

☞ Note

The balance should be written in the Electronic Purse format in the card.

Doc No	CIS-2XXX SPECIFICATION	REV	PAGE	DATE
91000060		B	47 OF 57	2007. 10. 01.

3 SECRET KEY

3.1 “R51” : Change ‘Secret Key’ to a new key

☞ Command Format

SOH	Null	Length	STX	“R51”	DATA	ETX	Bcc
-----	------	--------	-----	-------	------	-----	-----

☞ Command Data Structure

Sector	KEY A	KEY B
0x00 – 0x0f	0x00 – 0xff	0x00 – 0xff
1Byte (Hex)	6Byte (Hex)	6Byte (Hex)

☞ Positive Response Format

SOH	Null	Length	STX	“R51”	GOOD	0x01	ETX	Bcc
-----	------	--------	-----	-------	------	------	-----	-----

☞ Negative Response Format

SOH	Null	Length	STX	“R51”	E-Code	0x00	ETX	Bcc
-----	------	--------	-----	-------	--------	------	-----	-----

☞ Note

CIS-2000 Series ‘Secret Key’ Default – Key Set 0

KEY A : FFFFFFFF

KEY B : FFFFFFFF

3.2 “R52” : Change ‘Secret Key’ to all the same key value

☞ Command Format

SOH	Null	Length	STX	“R52”	DATA	ETX	Bcc
-----	------	--------	-----	-------	------	-----	-----

☞ Command Data Structure

KEY A	KEY B
0x00 – 0xff	0x00 – 0xff
6Byte (Hex)	6Byte (Hex)

☞ Positive Response Format

SOH	Null	Length	STX	“R52”	GOOD	0x01	ETX	Bcc
-----	------	--------	-----	-------	------	------	-----	-----

☞ Negative Response Format

SOH	Null	Length	STX	“R52”	E-Code	0x00	ETX	Bcc
-----	------	--------	-----	-------	--------	------	-----	-----

☞ Note

CIS-2000 Series ‘Secret Key’ Default – Key Set 0

KEY A : FFFFFFFF

KEY B : FFFFFFFF

Doc No	CIS-2XXX SPECIFICATION	REV	PAGE	DATE
91000060		B	48 OF 57	2007. 10. 01.

3.3 “R53” : Select ‘Secret Key Index’

☞ Command Format

SOH	Null	Length	STX	“R53”	DATA	ETX	Bcc
-----	------	--------	-----	-------	------	-----	-----

☞ Command Data Structure

Index
0x01 – 0x02
1Byte (Hex)

☞ Positive Response Format

SOH	Null	Length	STX	“R53”	GOOD	0x01	ETX	Bcc
-----	------	--------	-----	-------	------	------	-----	-----

☞ Negative Response Format

SOH	Null	Length	STX	“R53”	E-Code	0x00	ETX	Bcc
-----	------	--------	-----	-------	--------	------	-----	-----

☞ Data Variable

<Index>

Code	Setting	Detail
0x01	KEY A	Select ‘Secret Key A’
0x02	KEY B	Select ‘Secret Key B’

☞ Note

CIS-2000 Series ‘Secret Key Index’ Default

‘Secret Key Index ‘ : KEY A

3.4 “R54” : Change RF card ‘Secret Key’ to other key

☞ Command Format

SOH	Null	Length	STX	“R54”	DATA	ETX	Bcc
-----	------	--------	-----	-------	------	-----	-----

☞ Command Data Structure

Sector	KEY A	Access	KEY B
0x00 – 0x0f	0x00 – 0xff	0x00 – 0xff	0x00 – 0xff
1Byte (Hex)	6Byte (Hex)	4Byte (Hex)	6Byte (Hex)

☞ Positive Response Format

SOH	Null	Length	STX	“R54”	GOOD	0x01	ETX	Bcc
-----	------	--------	-----	-------	------	------	-----	-----

☞ Negative Response Format

SOH	Null	Length	STX	“R54”	E-Code	0x00	ETX	Bcc
-----	------	--------	-----	-------	--------	------	-----	-----

☞ Warning

If you use this command incorrectly, it couldn’t be authenticated from the card.

Doc No	CIS-2XXX SPECIFICATION	REV	PAGE	DATE
91000060		B	49 OF 57	2007. 10. 01.

3.5 “R55” : Change ‘Secret Key’ to a new key from Key Set Number.

☞ Command Format

SOH	Null	Length	STX	“R55”	DATA	ETX	Bcc
-----	------	--------	-----	-------	------	-----	-----

☞ Command Data Structure

Key Set	Sector	KEY A	KEY B
0x00 – 0x02	0x00 – 0x0f	0x00 – 0xff	0x00 – 0xff
1 Byte(Hex)	1Byte (Hex)	6Byte (Hex)	6Byte (Hex)

☞ Positive Response Format

SOH	Null	Length	STX	“R55”	GOOD	0x01	ETX	Bcc
-----	------	--------	-----	-------	------	------	-----	-----

☞ Negative Response Format

SOH	Null	Length	STX	“R55”	E-Code	0x00	ETX	Bcc
-----	------	--------	-----	-------	--------	------	-----	-----

☞ Note

<Key Set>

Code	Detail
0x00	Key Set 0
0x01	Key Set 1
0x02	Key Set 2

3.6 “R56” : Change ‘Secret Key’ to all the same key value from Key Set Number.

☞ Command Format

SOH	Null	Length	STX	“R56”	DATA	ETX	Bcc
-----	------	--------	-----	-------	------	-----	-----

☞ Command Data Structure

Key Set	KEY A	KEY B
0x00 – 0x02	0x00 – 0xff	0x00 – 0xff
1 Byte(Hex)	6Byte (Hex)	6Byte (Hex)

☞ Positive Response Format

SOH	Null	Length	STX	“R56”	GOOD	0x01	ETX	Bcc
-----	------	--------	-----	-------	------	------	-----	-----

☞ Negative Response Format

SOH	Null	Length	STX	“R56”	E-Code	0x00	ETX	Bcc
-----	------	--------	-----	-------	--------	------	-----	-----

☞ Note

<Key Set>

Code	Detail
0x00	Key Set 0
0x01	Key Set 1
0x02	Key Set 2

Doc No	CIS-2XXX SPECIFICATION	REV	PAGE	DATE
91000060		B	50 OF 57	2007. 10. 01.

4 RF DETECT

4.1 "R61" : RF card detect in antenna area

☞ Command Format

SOH	Null	Length	STX	"R61"	ETX	Bcc
-----	------	--------	-----	-------	-----	-----

☞ Positive Response Format

SOH	Null	Length	STX	"R61"	GOOD	DATA	0x01	ETX	Bcc
-----	------	--------	-----	-------	------	------	------	-----	-----

☞ Negative Response Format

SOH	Null	Length	STX	"R61"	E-Code	0x00	ETX	Bcc
-----	------	--------	-----	-------	--------	------	-----	-----

☞ Response Data Structure

Serial Number
Hex Code
4Byte

☞ Note

If the RF card is detected, this command send the serial number to host. But, it doesn't authenticate the Secret Key of the RF card.

Doc No	CIS-2XXX SPECIFICATION	REV	PAGE	DATE
91000060		B	51 OF 57	2007. 10. 01.

ERROR DETAIL

<GOOD>

Code : 0x0000
Description: Normal Execution
Procedures: None

<NOT_DEFINE_COMMAND>

Code : 0x2001
Description : Using the command that does not defined in this model.
Action : Use the valid command in this model.

<NOT_USE_COMMAND>

Code : 0x2002
Description : Not available command in this model.
Action : Use the valid command in this model.

<COMM_FRAME_ERROR>

Code : 0x2003
Description : Sending the command that has the invalid communication frame.
Action : Check the data format and the corresponding module specification.

<CARD_JAM>

Code : 0x2004
Description : When the card is jammed.
Action : Remove the jammed card.

<NO_CARD>

Code : 0x2005
Description : No cards.
Action : Insert the card.

Doc No	CIS-2XXX SPECIFICATION	REV	PAGE	DATE
91000060		B	52 OF 57	2007. 10. 01.

<CARD_PRESENT>

Code : 0x2006

Description : When the card exists already in the terminal.

Action : Eject the card.

<BUSY>

Code : 0x2007

Description : When the terminal is running or busy.

Action : Wait until the previous operation is completed.

<RTC_ERROR>

Code : 0x2008

Description : When the RTC time is incorrect by internal terminal or incorrect input data.

Action : RTC time resetting

<TWO_MORE>

Code : 0x2009

Description : When more than two cards exit in the terminal simultaneously.

Action : Remove the Card .

<CARD_ERROR>

Code : 0x200B

Description : When the using card error, commonly occur in MSRW.

Action : Exchange the Card

<DISPENSER_COMM_ERROR>

Code : 0x2101

Description : Dispenser communication error

Action : Check the communication line and reset the terminal.

Doc No	CIS-2XXX SPECIFICATION	REV	PAGE	DATE
91000060		B	53 OF 57	2007. 10. 01.

<DISPENSER_CARTRIDGE_EMPTY>

Code : 0x2105

Description : No card at the Issuing machine.

Action : Load the card at the Cartridge.

<DISPENSER_CARTRIDGE_WARNING>

Code : 0x2107

Description : A few cards in the Issuing machine.

Action : Load the card at the Cartridge.

< DISPENSER_NO_CARTRIDGE_ERROR >

Error Code : 0x2113

Description : There is no cartridge in Issuing Machine

<MSRW_ERROR>

Code : 0x2200

Description : The MS Reader/Writer that cannot use in this model.

Action : Change the MS Reader/Writer.

<MSRW_COMM_ERROR>

Code : 0x2201

Description : The MS Reader/Writer communication error.

Action : Check the communication line and reset the terminal.

<MSRW_WRITE_ERROR>

Code : 0x2202

Description : Error when the MS Reader/Writer is writing on the card.

Action : Clean the header and check the card.

Doc No	CIS-2XXX SPECIFICATION	REV	PAGE	DATE
91000060		B	54 OF 57	2007. 10. 01.

<MSRW_READ_ERROR>

Code : 0x2203

Description : Error when the MS Reader/Writer is reading on the card.

Action : Clean the header and check the card.

<IC_CONTACT_ERROR>

Code : 0x2204

Description : Error while the terminal contacts the IC card.

Action : Be sure that the current card is an IC card.

<IC_CONTROL_ERROR>

Code : 0x2205

Description : Error while the terminal executes the IC card command.

Action : Check if the command is able to use in the contacted card.

<MS BLANK ERROR >

Code : 0x2209

Description : No data on the magnetic card

Action : Write data on the magnetic card.

<RF_ERROR>

Code : 0x2300

Description : Unavailable RF module.

Action : Change the RF MODULE

<RF_COMM_ERROR>

Code : 0x2301

Description : Communication error at the RF Module.

Action : Check the connection socket

Doc No	CIS-2XXX SPECIFICATION	REV	PAGE	DATE
91000060		B	55 OF 57	2007. 10. 01.

<RF_AUTHEN_ERROR>

Code : 0x2302

Description : Authentication Error at the RF Module.

Action : Change the 'SECRET KEY'

<RF_WRITE_ERROR>

Code : 0x2303

Description : Error while the terminal writes at the RF Card.

Action : Be sure that the card exists in the detection range.

<RF_READ_ERROR>

Code : 0x2304

Description : Error while the terminal reads at the RF Card.

Action: Be sure that the card exists in the detection range.

<RF_DETECT_ERROR>

Error Code : 0x2305

Description : No RF Card.

Action : Insert the RF Card into the terminal.

<RF_VALUE_ERROR>

Code : 0x2306

Description : Error while the value increases(or decreases) at the RF Card.

Action: Be sure that the card exists in the detection range.

<FLASH_ERROR>

Code : 0x2400

Description : Unavailable FLASH memory ic.

Action : Change the main control board

Doc No	CIS-2XXX SPECIFICATION	REV	PAGE	DATE
91000060		B	56 OF 57	2007. 10. 01.

<COLLECTOR_COMM_ERROR>

Error Code : 0x2501

Description : Collector communication error.

< COLLECTOR_NO_CARTRIDGE_ERROR >

Error Code : 0x2503

Description : There is no cartridge in Collector Machine

<COLLECTOR_CARTRIDGE_FULL_ERROR>

Error Code : 0x2505

Description : Collector Cartridge is Card full

Doc No	CIS-2XXX SPECIFICATION	REV	PAGE	DATE
91000060		B	57 OF 57	2007. 10. 01.

Precautions

1. Check if the card exists in stacker. Otherwise, it may not issue the card.